

# INSTRUCTION MANUAL

NOVA 2609

NOVA 3212

NOVA TN 3212

NOVA P-OS 3212

Industrial automatic heavy duty sewing  
machine with unison feed

**HD**  
*texi*

# Industrial automatic heavy duty sewing machine with unison feed TEXI NOVA series

General view:



Advantages:

- 351x125mm extra large operation space, easy to sew bigger products.
- Fully automatic thread trimming, foot lifting, bartack, thread release, soft start functions, etc.
- Pneumatically powered foot lifting and bar tacking functions - much more durable and reliable than the solenoid one.
- Can be used with different optional devices such as presser feet, swing guides, and folders, making the machine use much wider and more flexible. (For models with double-needle can be used different needle gauge sets)
- HP function allows the user to climb over the thick spots with one button, changing the alternating presser foot height to a maximum of 9mm, making it easy to sew through the cross seams.
- Maximal sewing speed of 3400spm and large hook can reduce the frequency of changing the bobbin and improve the production efficiency.

# 1. External parts disassembling



1. Take off the side cover according to 3 Phillips screws

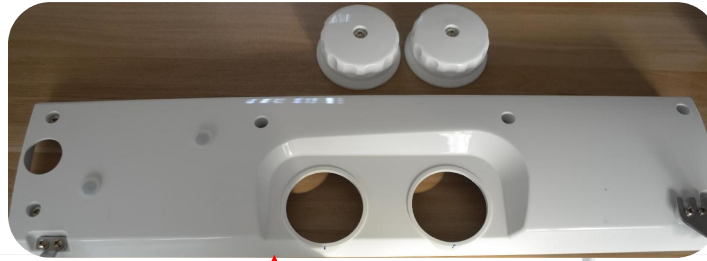

2. Take off the push plate. To be careful to press down the spring at the right side

3. Take off two phillips screw with gasket, then take out the feeding adjusting dial. Take off six phillips screws and put down the plastic cover.

4. Take off three phillips screws and put down the handwheel. Take off four phillips screws and put down the motor cover.

# 1. External parts disassembling

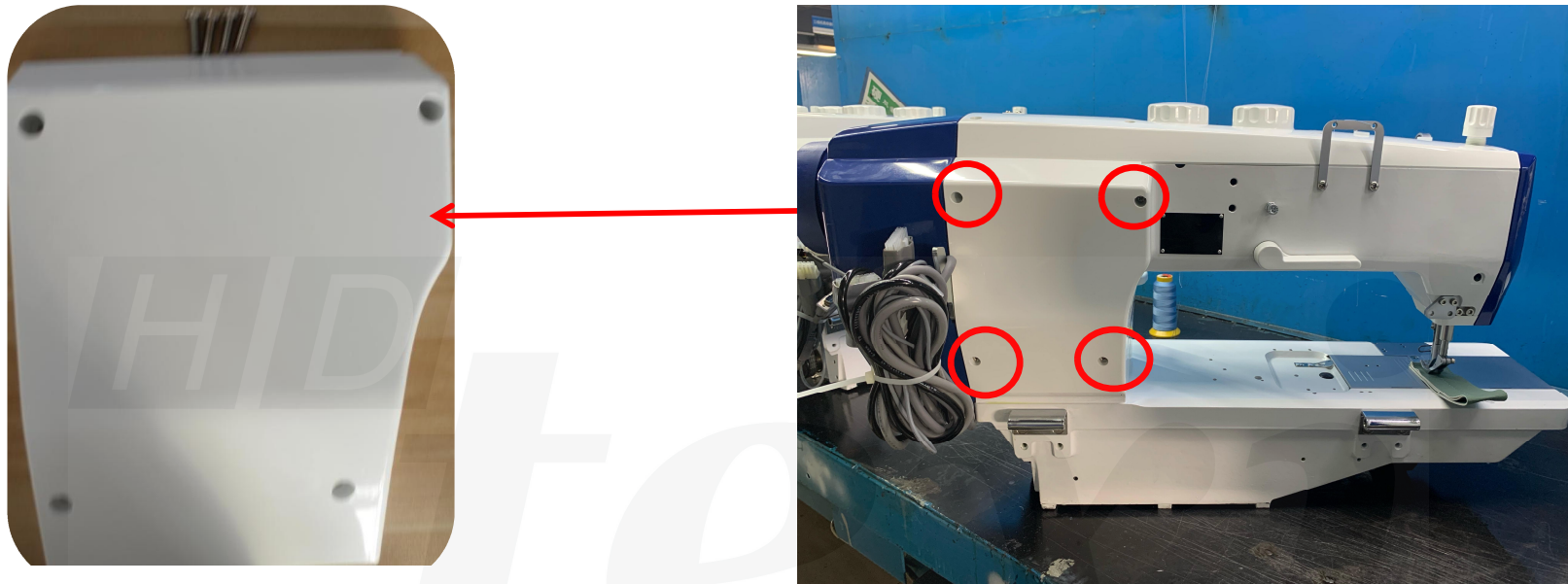

1. Take off four phillips screws and put down the back cover and gasket.

## 2. Presser foot mechanism disassembling

Effect: Press the material and prevent it from dislocations, ups and downs. It can cooperate closely with feeding mechanism, needle bar mechanism, then feed a stitch length. If it presses the material loosely, it can result in stitch jumping.

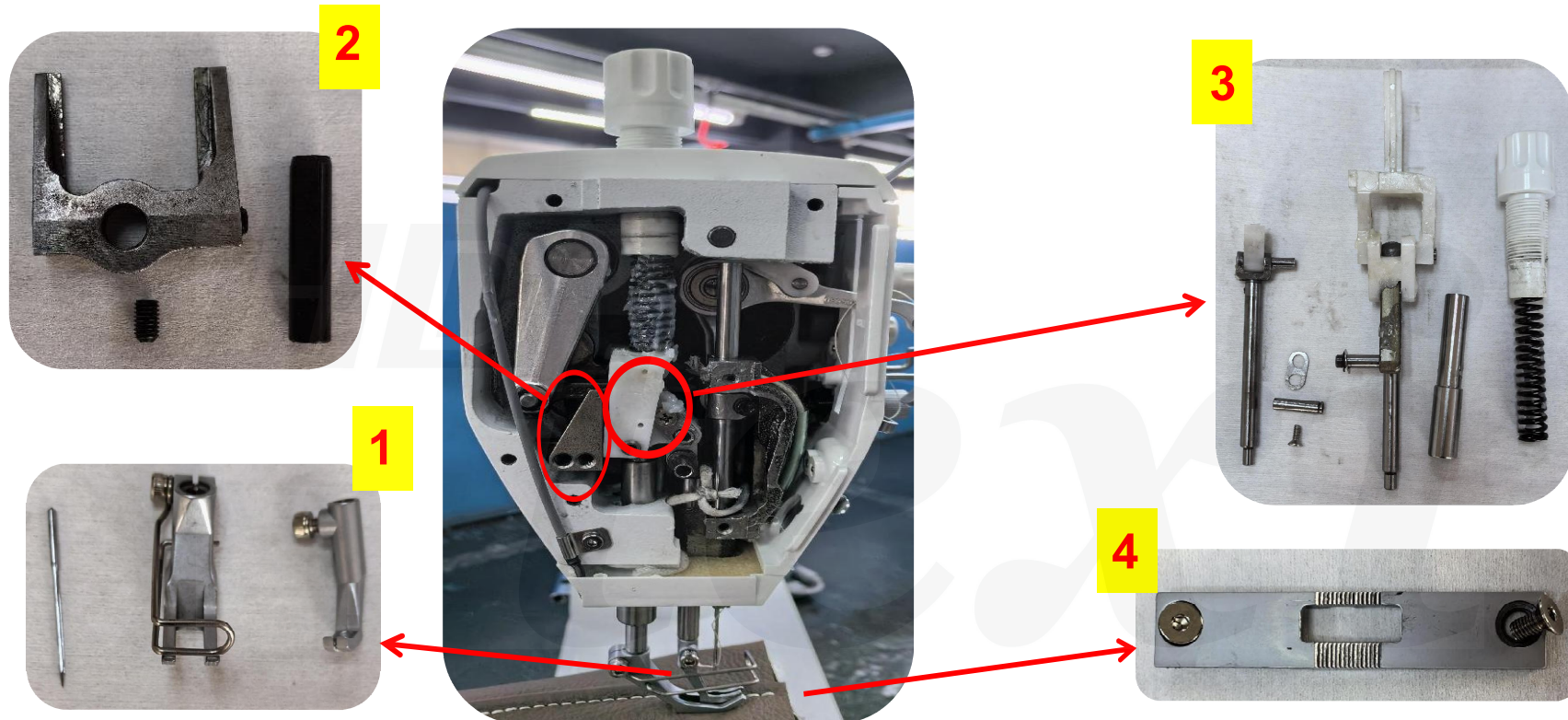

1. Loosen the screws of the inner and outer presser feet and remove the inner and outer presser feet.
2. Loosen the hex screws and remove the pins and triangle component assemblies.
3. Loosen the adjustment bolt to remove the adjustment spring. Remove the screws and washers on the alternating presser foot rod assembly and take out the pins. Loosen the screws on the upper feed shaft crank assembly and remove the pins. Loosen the fixing screws on the presser foot rod sleeve assembly and pull down the presser foot rod sleeve. Gently rotate and remove the alternating presser foot rod assembly and take out the small presser foot rod assembly.
4. Remove the two hex screws on the needle plate and take off the needle plate.

### 3. Needle bar mechanism disassembling

Function: The needle bar performs vertical and horizontal movements to sew. The primary function is to utilize the take-up lever and the needle bar's movement to guide the thread through the fabric, creating loops that intertwine with the bobbin thread, completing the stitches at the bottom. Simultaneously, under the action of the swing shaft, the needle works in coordination with the small presser foot and the main presser foot, along with the feed dogs, to send out a stitch.

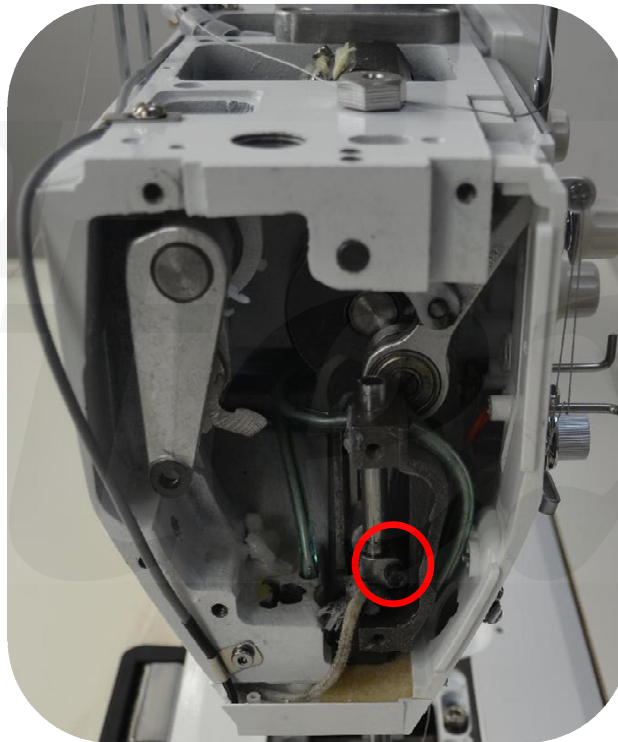

U-shaped LED light for workspace, ensuring clear stitches around the sewing area without shadows.

1. Use a 2mm hex wrench to loosen and remove the fixing screws; remove the needle. Loosen and remove the screws on the thread guide plate.

2. Remove the two hex screws on the LED light.

### 3. Needle bar mechanism disassembling

1. Loosen and remove the hex screws from the left and right sides of the needle bar swing shaft, one on each side, and remove the retaining rings.

2. Loosen the screw of the needle bar feed connecting rod assembly and remove the needle bar feed shaft assembly. Note: Be careful of the hot glue near the tightening hoop of the Madaz area. The wires must not be pulled off.

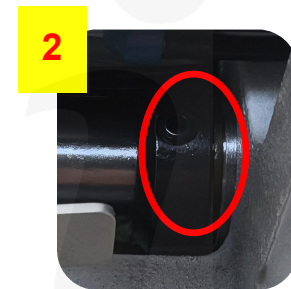
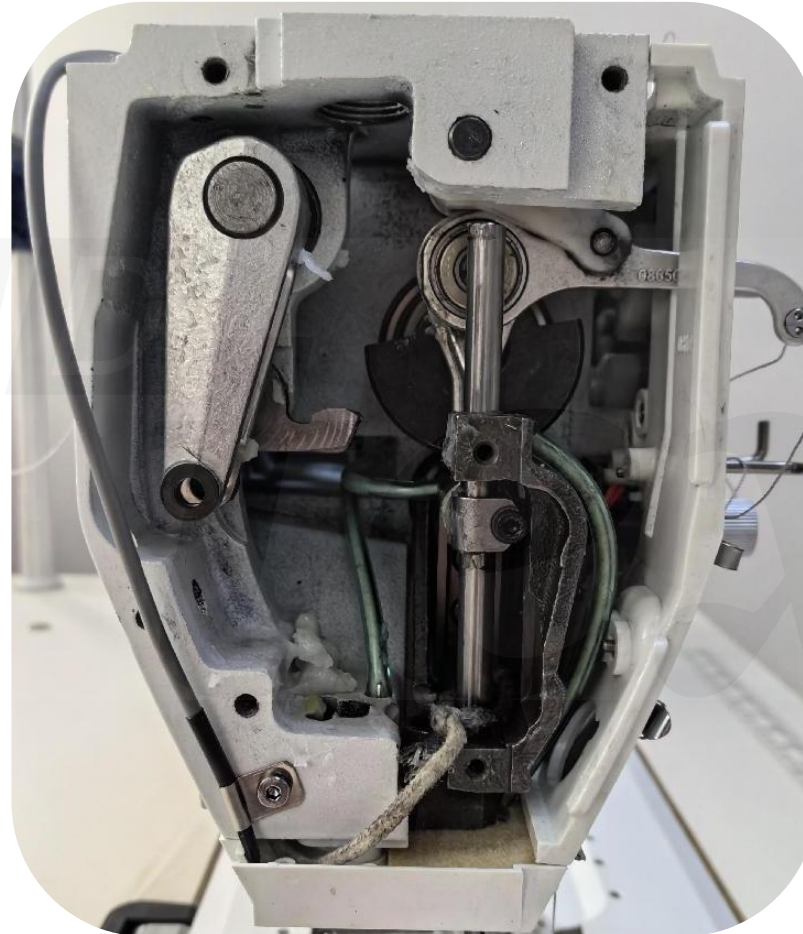

**Note: Be careful with the wires as they are fixed with hermetic glue and must not be pulled off.**

## 4. Thread take-up mechanism disassembling

Function: Feeding and retrieving thread. The rotary hook catches the upper sewing thread, enlarging the thread loop. The fabric thickness and stitch length require a sufficient amount of thread, but any excess thread needs to be retracted; otherwise, it will get tangled in the rotary hook, preventing normal sewing. This model is equipped with a sliding-type thread take-up lever.

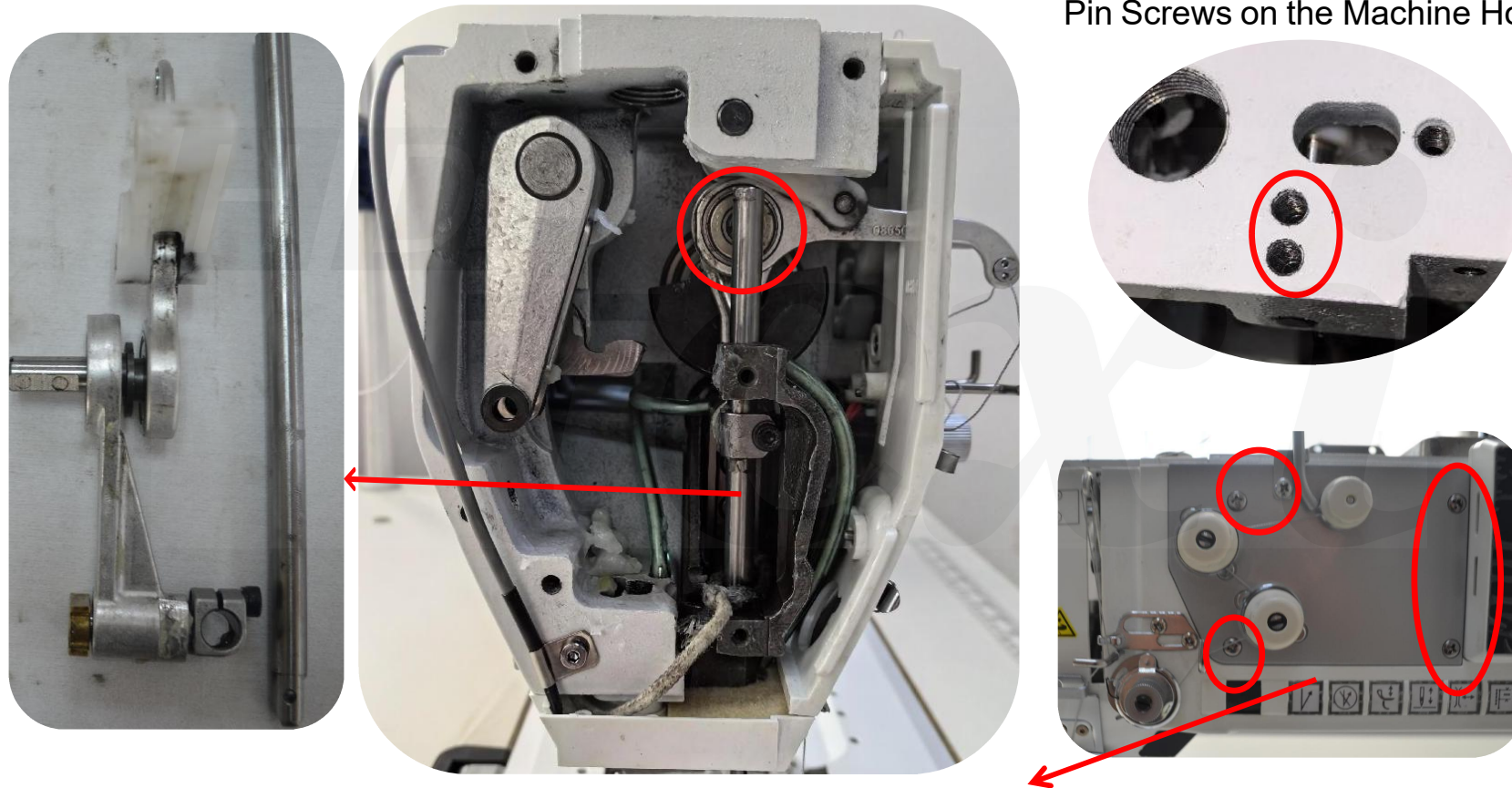

After removing the needle bar, unscrew the six cross-head screws on the single-needle thread tension assembly but do not remove the assembly. This will facilitate the removal of the thread take-up lever. Loosen the two pins and screws on the thread take-up lever, and then remove the eccentric pin and the thread take-up lever.



## 5. Thread tension mechanism disassembling

Function: Adjusting the thread tension to regulate the intertwining point of the upper and lower threads at the center of the fabric. The upper thread tensioner adjusts the tension of the upper thread, while the lower thread tensioner refers to the spring plate on the bobbin case of the rotary hook to adjust the tension of the lower thread.

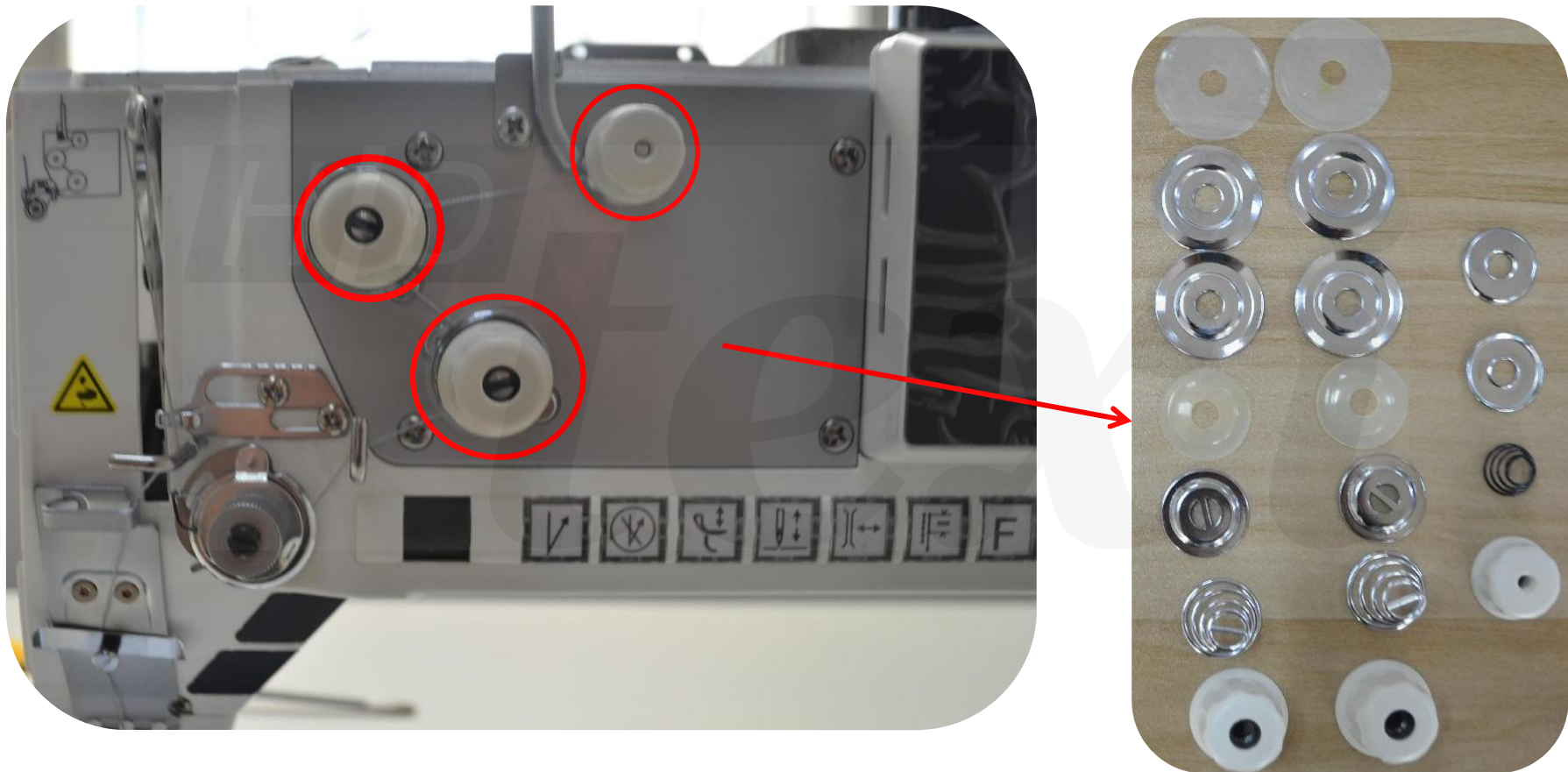

Disassemble the three main thread tensioners into individual components.

## 6. Thread cutting mechanism disassembling

Function: Cutting the upper and lower threads after sewing is completed. This function is widely used to improve sewing efficiency, reduce thread waste, and save labor costs. It will be extensively applied in future sewing machines. The upper spacer thickness is 0.1mm, and the number of spacers added depends on the height of the movable knife.

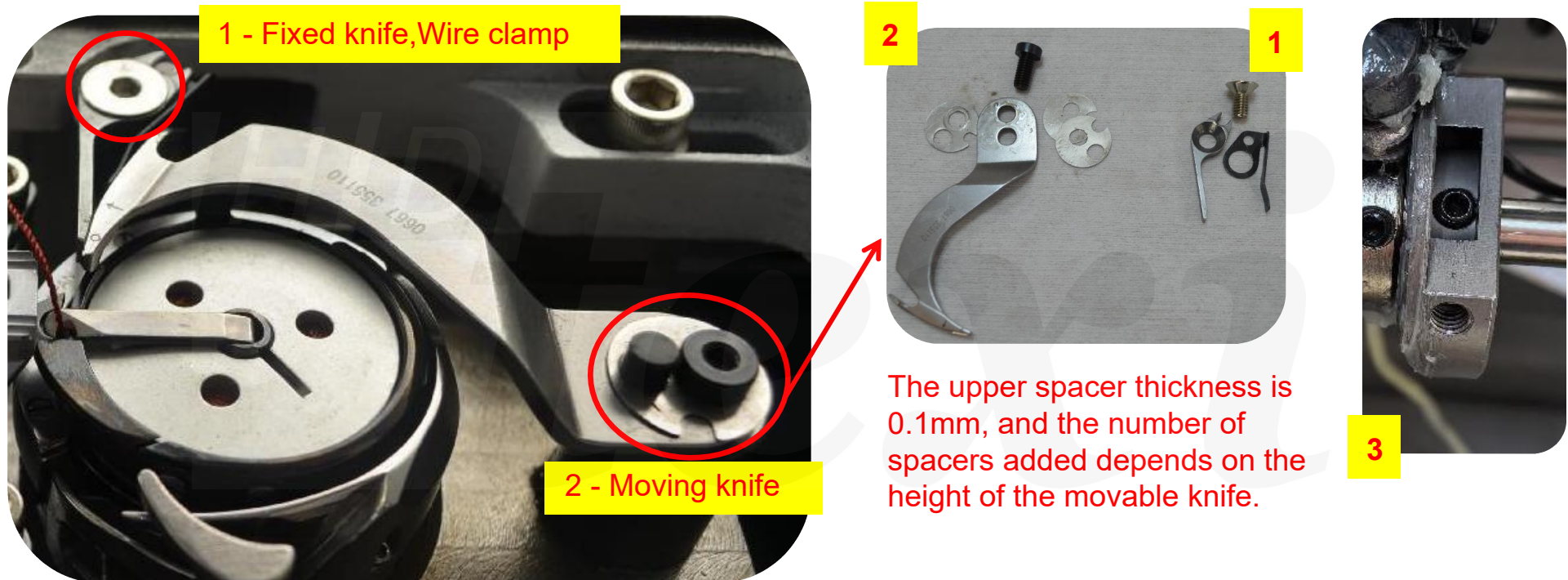

1. Remove one hex socket head cap screw to take off the fixed knife and thread clamp plate.
2. Remove one hex socket head cap screw to take off the movable knife and three spacers. Note: Do not omit any spacers; be careful not to injure your hands when removing the movable knife.
3. Loosen the two hex socket head cap screws on the thread-cutting cam.

## 6. Thread cutting mechanism disassembling

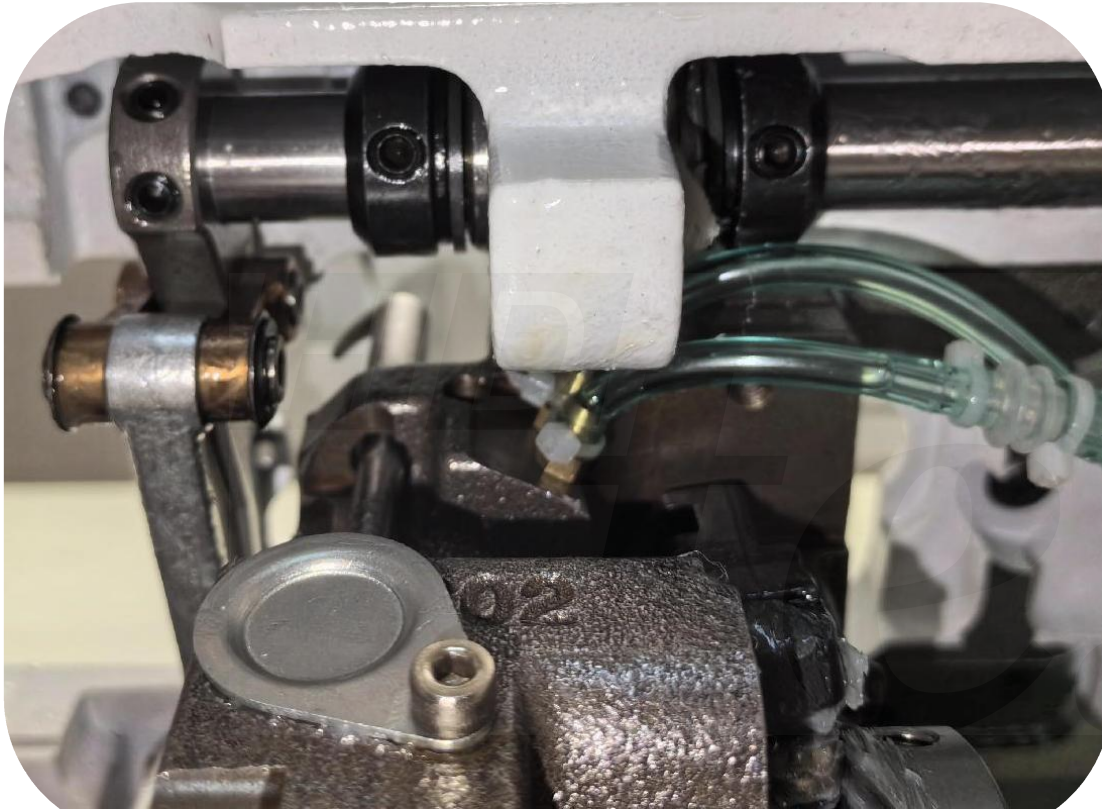

The thread-cutting electromagnet is assembled with the rotary hook base, and the oil pipe and electromagnet wiring are assembled on a single connector. This component is not to be disassembled.

## 7. Rotary hook mechanism disassembling

Function: Hooks the thread, releases the thread, and completes the interlocking of the lower thread. It is a horizontal full-rotation rotary hook, with two sets for left and right needles.

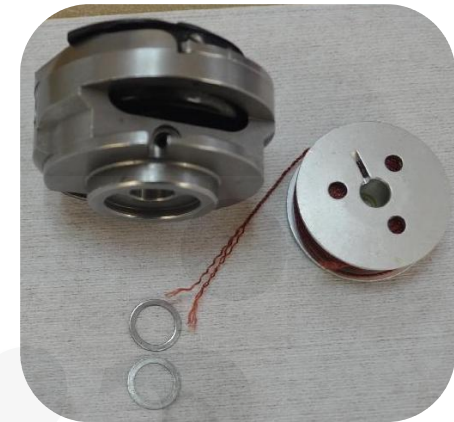
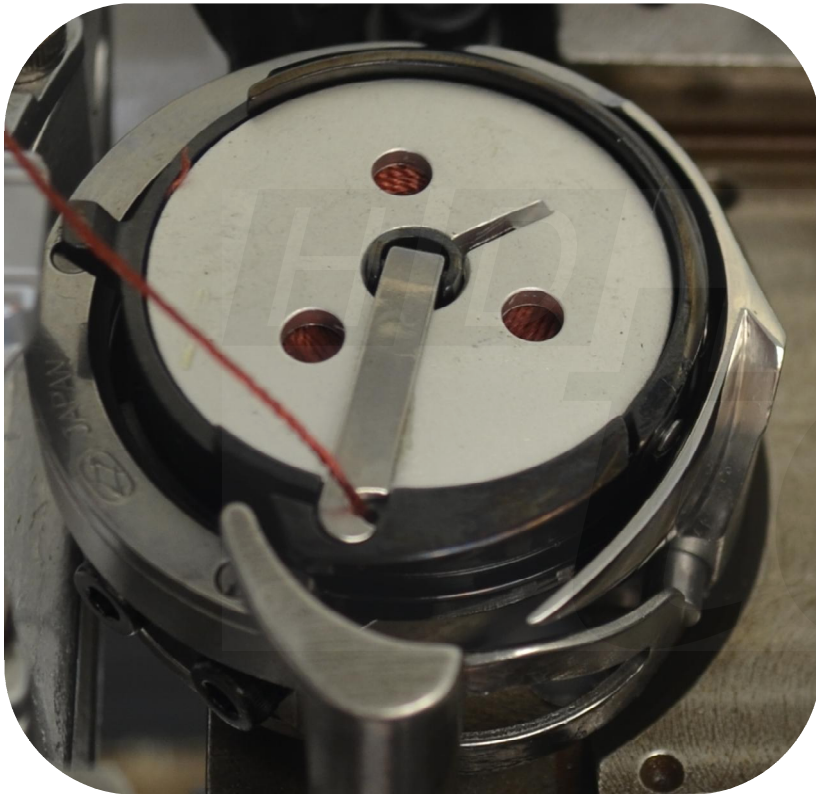

Loosen the hex socket head cap screw for the thread hook, and open the thread hook in the direction of the arrow. Loosen the two 2.5mm hex socket head cap screws for the rotary hook, and remove the rotary hook lock core. If the rotary hook cannot be removed, loosen the two feed dog screws and remove the feed dog.

**Note: Do not omit any spacers**

## 7. Rotary hook shaft and Lower right shaft mechanism disassembling

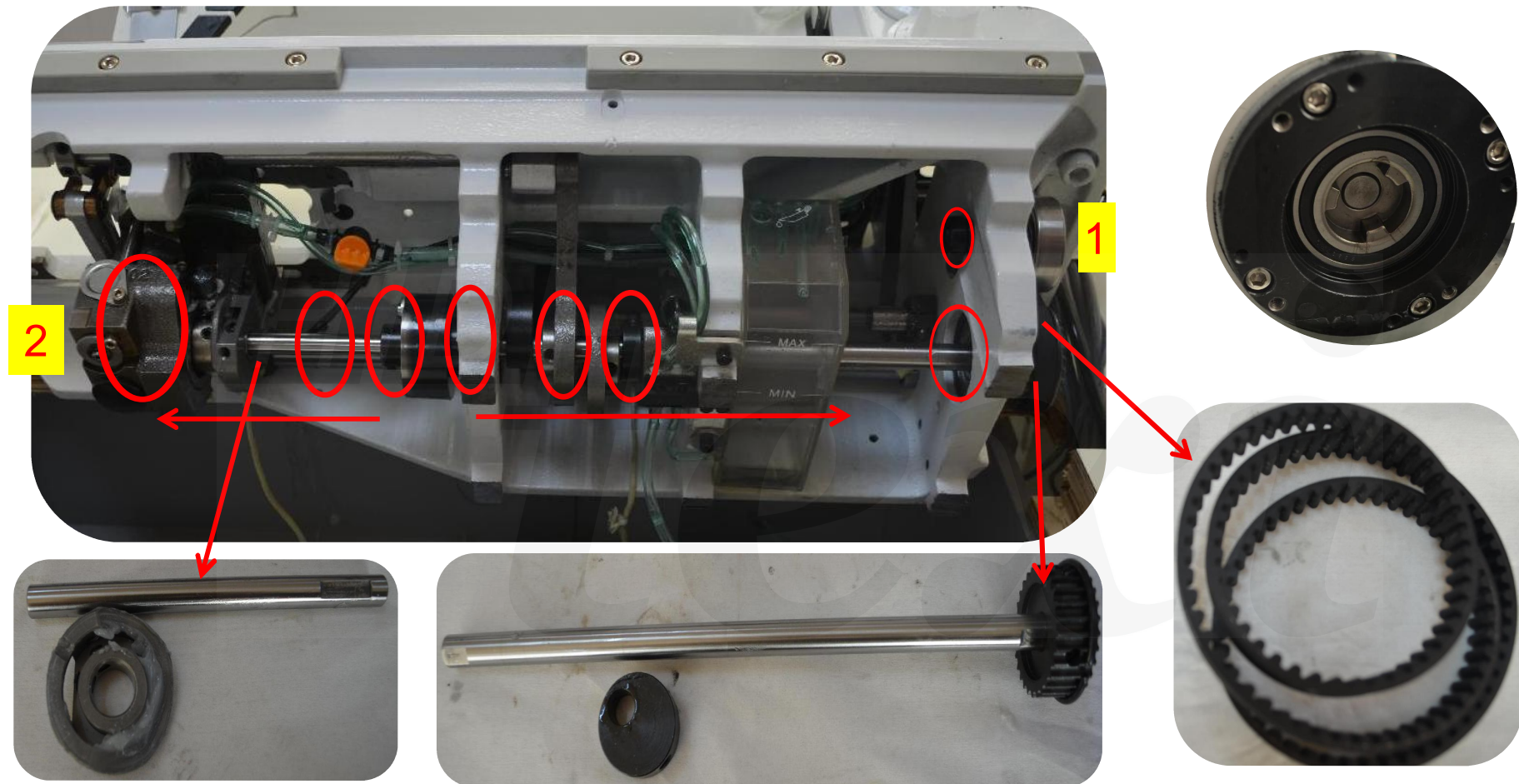

Use an adjustable wrench to loosen the upper nut and adjust the tension on the belt tension pulley. Remove the pulley and take off the belt.

From left to right, loosen the two hex socket head cap screws for the lower shaft cam, the four screws for the lower shaft clutch assembly (left and right), the two hex socket head cap screws for the balance weight, the two hex socket head cap screws for the oil pump shaft, and the two screws for the right bearing sleeve. Remove the lower shaft assembly towards the right. Remove the lower right shaft from right to left, including the thread-cutting cam. (Detailed close-up on the next page.)

## 7. Rotary hook shaft and Lower right shaft mechanism disassembling



1. Remove the four hex socket head cap screws from the pulley assembly.

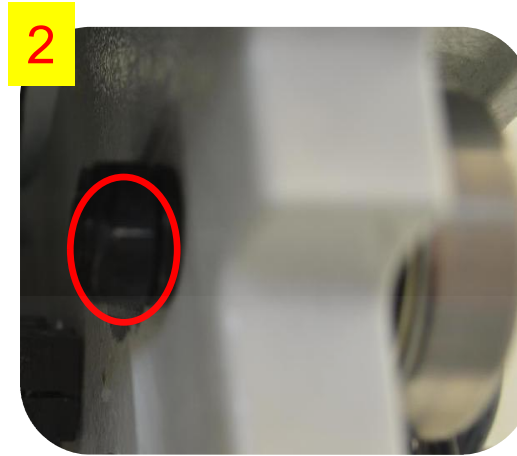

2. Use a wrench to loosen the nut on the belt tension adjustment wheel assembly, and use a flat-head screwdriver to adjust and loosen the belt tension.



3. Use a flat-head screwdriver to gently remove the belt to one side.



4. Loosen the four hex socket head cap screws for the clutch assembly (left and right).



## 8. Material feeding mechanism disassembling

The feed mechanism, also known as the feeding mechanism, is responsible for moving the fabric in a regulated manner, from point A to point B, with a consistent stitch length. The stitch length depends on the size of the stitch length adjuster, which is marked on the stitch length dial.

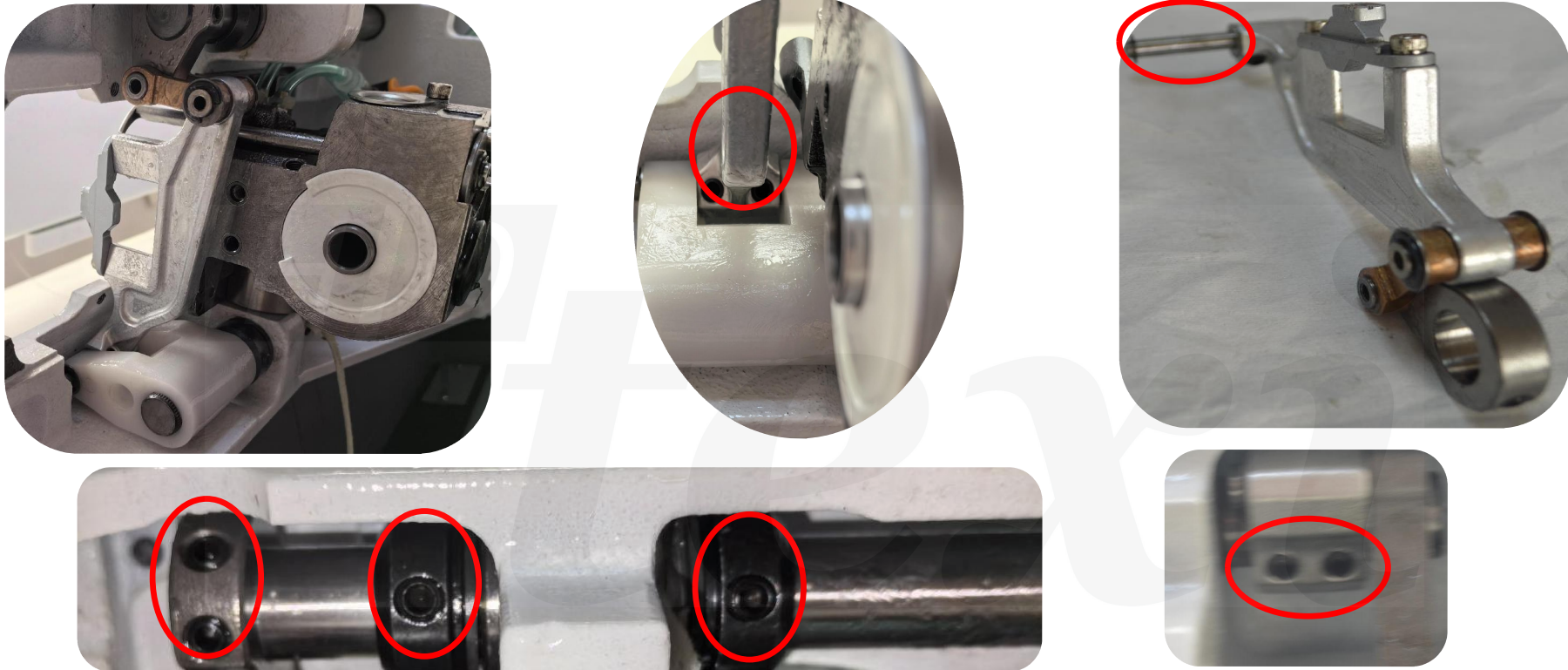

- Remove the feed dog.
- From left to right, loosen the two screws for the feed dog shaft retaining rings, and the two screws for the feed dog cam crank.
- Move the shaft to the right and remove the feed dog holder.
- Then, loosen the two hex socket head cap screws on the feed dog holder assembly and pull out the feed dog holder to remove the feed dog pins.
- Do not fully remove the feed shaft.
- Loosen the screws on the rotary hook base assembly, move the rotary hook base to the right, and then the feed dog holder assembly can be removed.

## 9. Stitch length adjustment mechanism disassembling

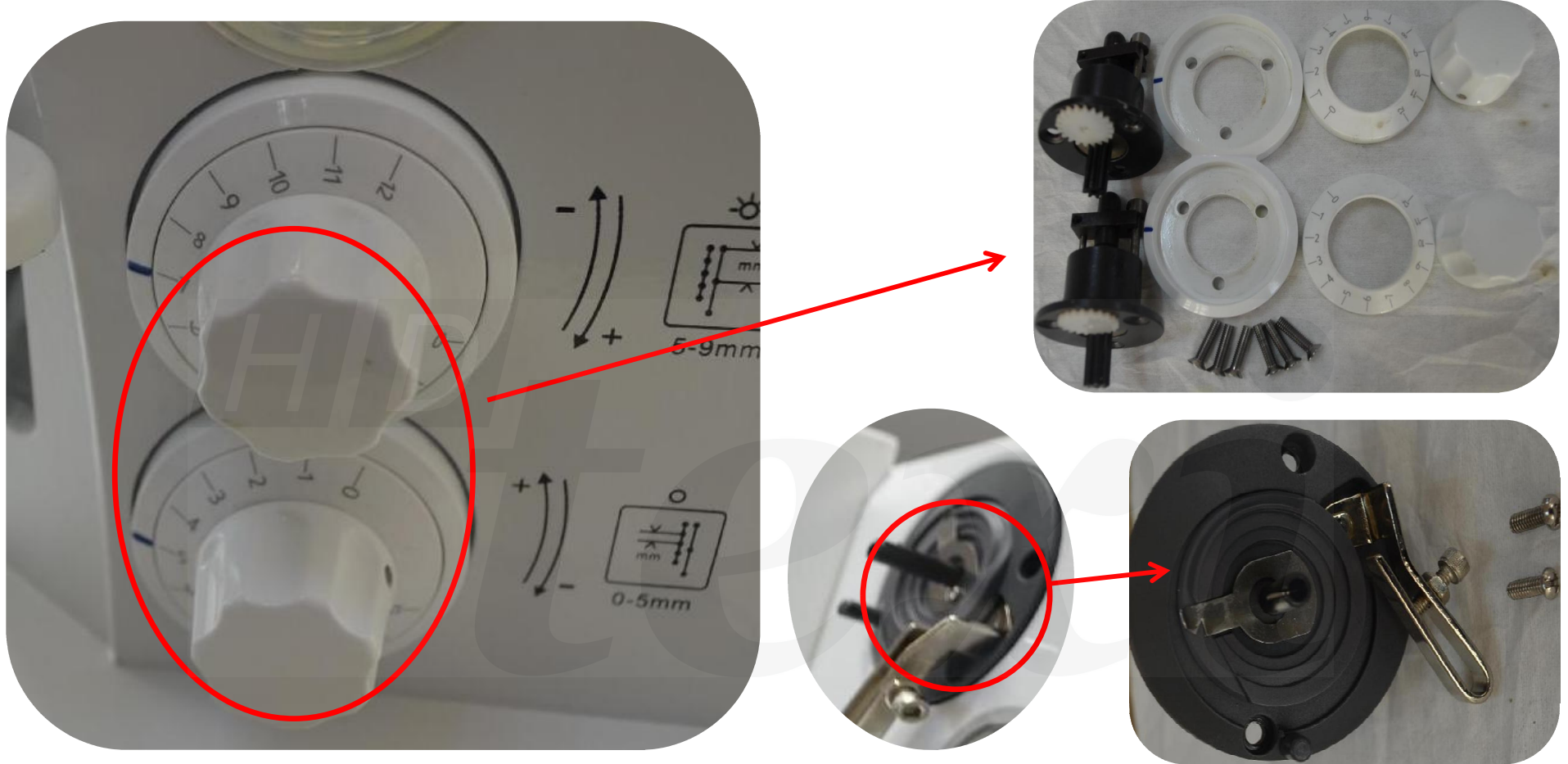

1. First, remove the two feed adjustment wheels. Then, following the diagram, remove the dial and the feed adjustment seat by unscrewing the six screws. Remove the feed adjustment assembly.

2. Remove the two screws for the thread guide and take off the thread guide.



## 10. Oil supply mechanism disassembling

Function: Lubrication, cooling, and temperature reduction to prevent component wear and reduce thread breakage. However, excessive oil can contaminate the fabric.

In the machine used "Plunger + Oil line" oil supply system, which looks as below:

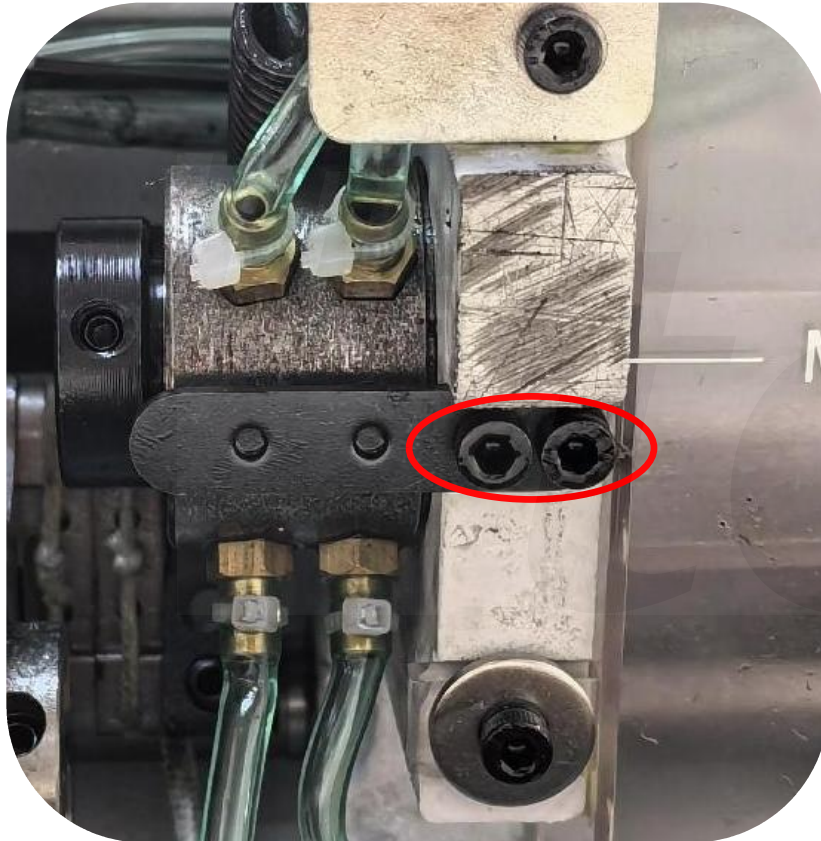

1. Remove the two hex socket head cap screws from the plunger cover plate. Take off the plunger cover plate, the two plunger springs, and the two plunger oil pumps.

2. For the Tit features a dual-piston oil pump.

# 11. Main motor mechanism disassembling

Function: Provides power to the sewing machine while controlling the thread-cutting speed.

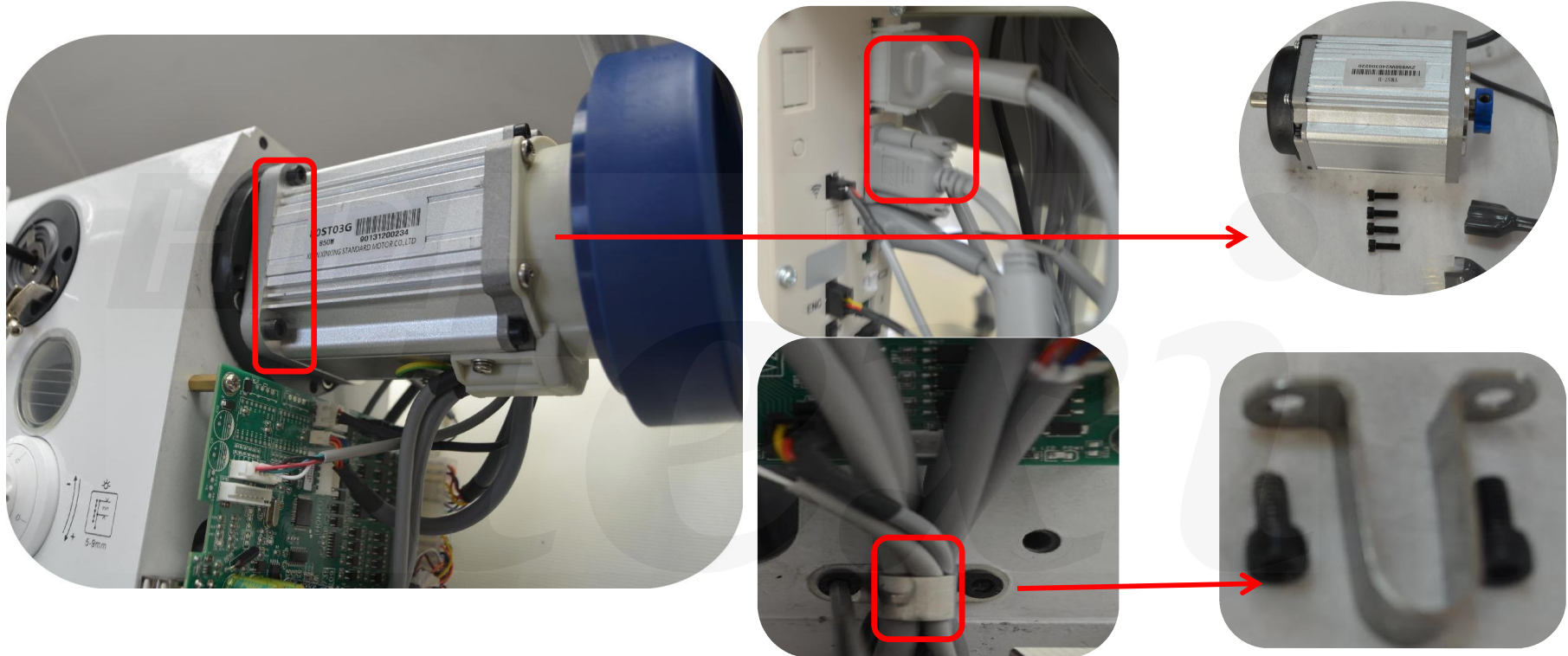

1. Disconnect the 4-pin and 5-pin connectors from the main motor. Note: Gently pull the locking tabs to avoid damaging the connectors.
2. Remove the four hex socket head cap screws from the main motor and take off the motor assembly. Note: Carefully manage the wiring that is wrapped around the motor.

## 11. Main motor mechanism disassembling

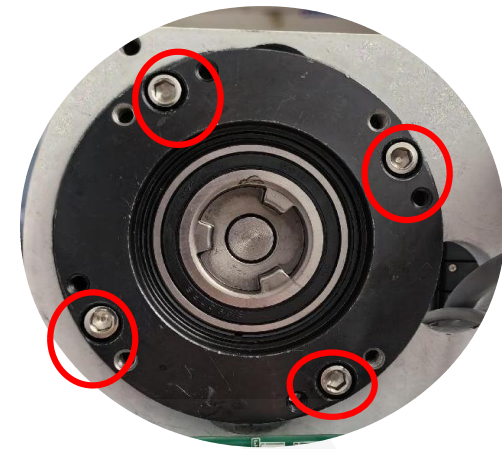
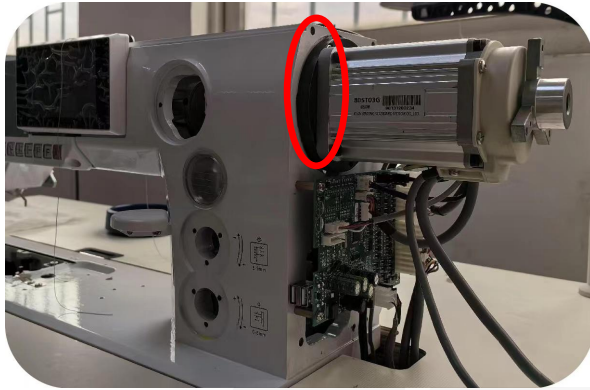

**CAUTION: Install the Belt!**

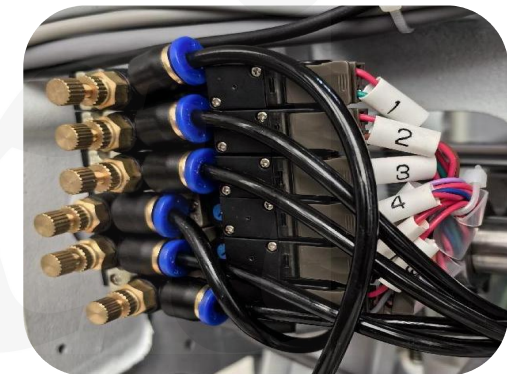

First, install the belt. Align the motor base assembly with the first screw hole on the sewing machine spindle (note: use the closest distance between the two screw holes). Tighten the plane screw first, then loosen it by half a turn. Tighten the four hex socket head cap screws on the motor base, then tighten the spindle plane screws. Ensure the plane screws are tightened to the correct torque. Finally, align the notches and tighten the motor.

Assemble the solenoid valve components in order from top (1) to bottom (6). Carefully insert the electrical connectors, making sure not to pull the wires.

- 1: Presser foot lift function
- 2: Presser foot alternating function
- 3: Reverse feeding/Bartack function
- 4: Second Stitch length function
- 5: Second thread tension function
- 6: First thread tension function

## 12. Material Feeding mechanism assembling

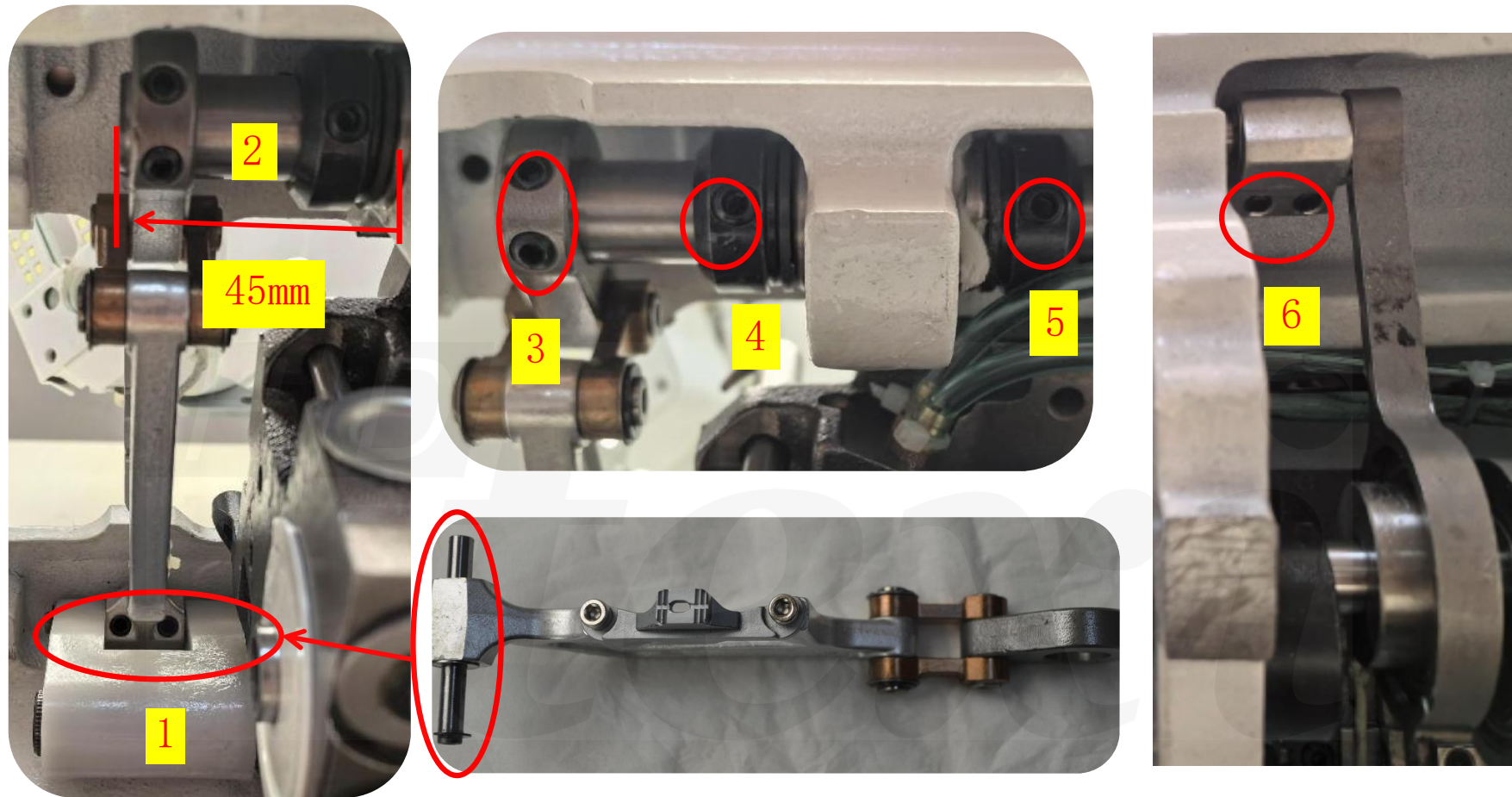

1. When assembling the feed dog holder with the crank, press the feed dog holder towards the snap ring and lock it in place using the two hex socket head cap screws as shown in the diagram. Ensure there is no gap between the left and right sides of the feed dog holder.
2. Sequentially install the feed dog crank → left and right retaining rings → feed dog crank onto the feed dog shaft. The left end of the feed dog shaft should extend 45mm. Lock in place using the retaining ring screws as shown in diagrams 4, 5, and 6. After tightening the retaining rings, ensure there is no gap between the left and right sides of the feed dog shaft and that it rotates smoothly. Further adjustments can be made as shown in diagram 3 before final tightening.

## 13. Stitch length adjustment mechanism assembling

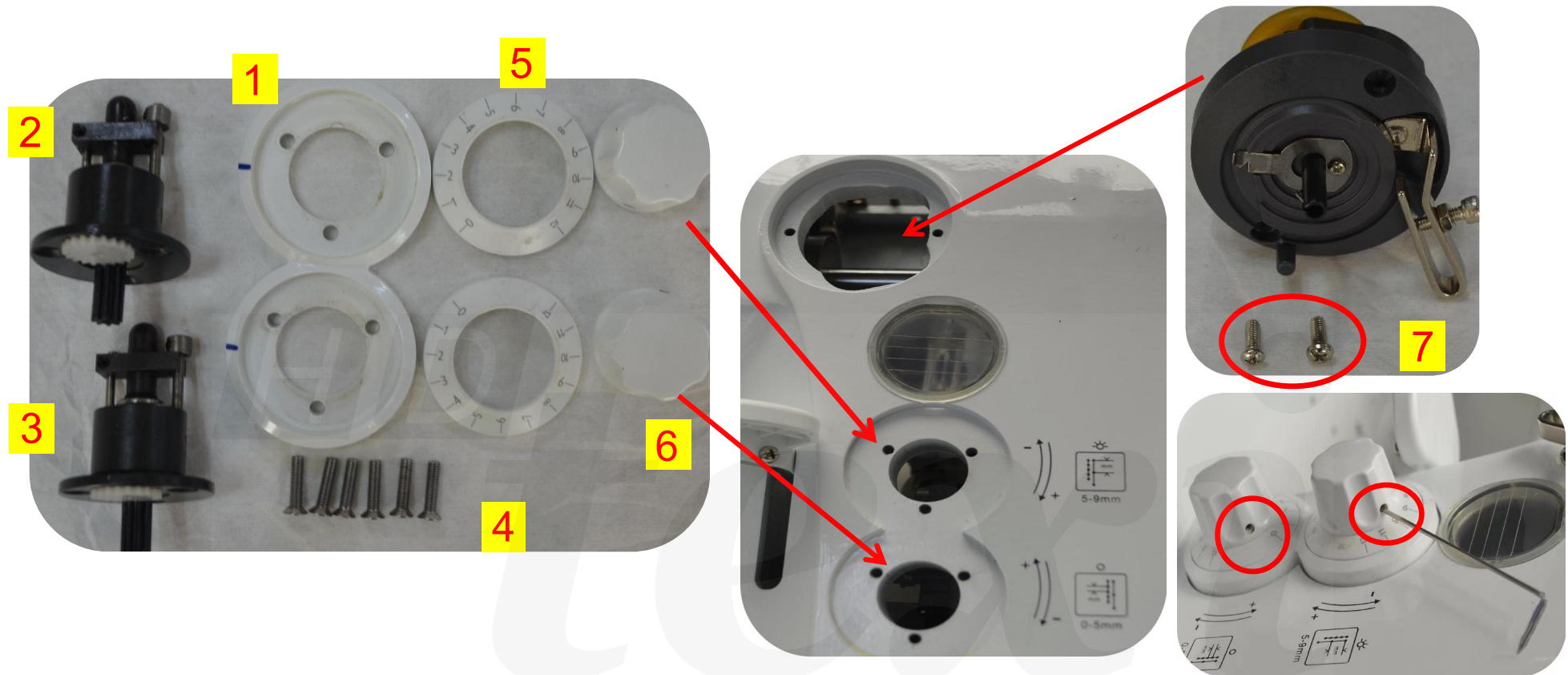

1. Install the stitch length adjustment base in order, with the blue scale line oriented to the left. Secure the six cross-head screws, ensuring not to overtighten to avoid damaging the plastic parts. Diagram 2 and 3 show different stitch length adjustment base components. Diagram 2 shows the long stitch length adjustment base mounted in the upper hole scale, and the short stitch length adjustment base mounted in the lower hole. Secure with the knob screws.
2. Install the thread guide into the arrow hole as shown in Diagram 7. Use two cross-head screws, ensuring not to overtighten to avoid damaging the plastic parts. The thread guide adjustment range should be between 85%-90%. If the thread guide is set below 85%, operators may frequently change the thread core; if set above 90%, it can cause excessive thread tension, affecting the sewing quality.

## 13. Stitch length adjustment mechanism assembling

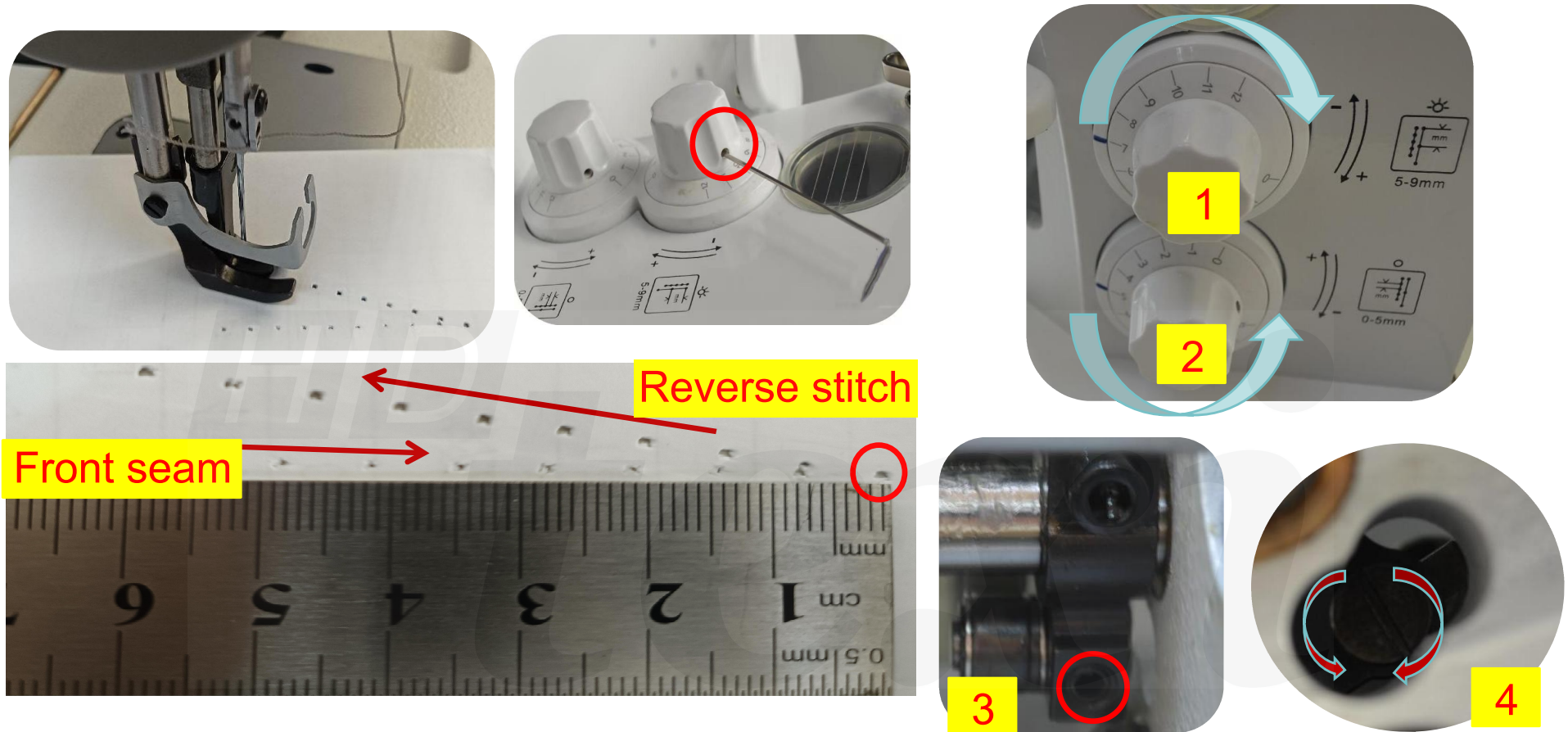

1. The upper stitch length dial (Diagram 1) has a range of 0–12 with adjustable long stitch lengths from 5 to 9mm. The lower stitch length dial (Diagram 2) has a range of 0–12 with adjustable short stitch lengths from 0 to 5mm.
2. Set the upper stitch length dial to 6. With the presser foot raised, place a piece of measurement paper underneath. Lower the presser foot, rotate the handwheel, and sew 10 stitches. Then, lift the presser foot and rotate the test paper 15°. Lower the presser foot, engage the reverse sewing lever, and sew another 10 stitches on the paper using the same method.
3. Measure the stitch length with a steel ruler. The stitch length difference between forward and reverse sewing should not exceed 10%. If it does, loosen the three fixing screws (Diagram 3) and adjust the eccentric shaft (Diagram 4) with a flat-head screwdriver until the requirements are met. Then, tighten the three screws from Diagram 3.

## 14. Needle swing mechanism assembling

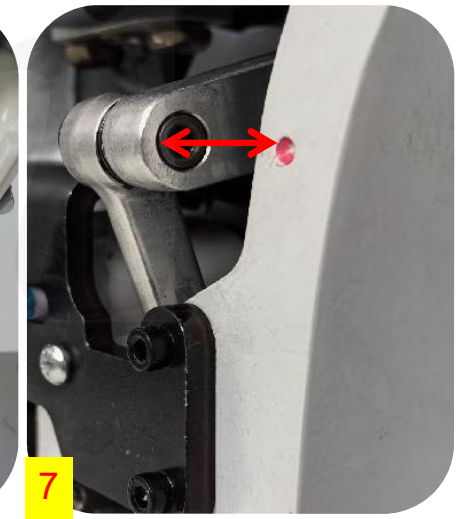
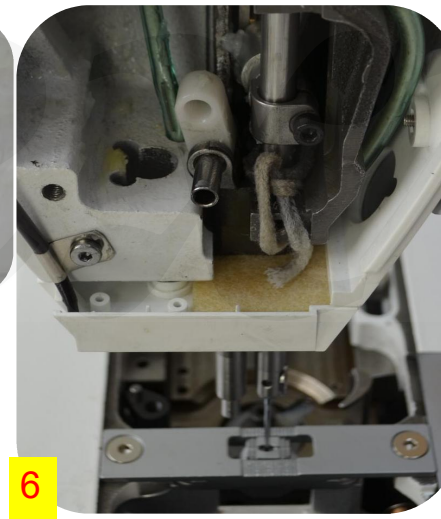
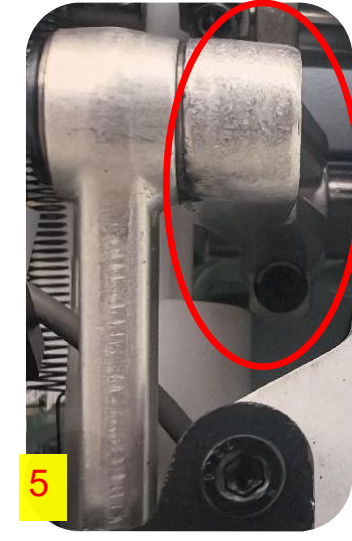
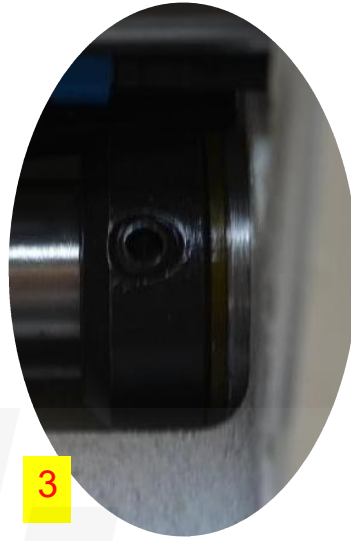
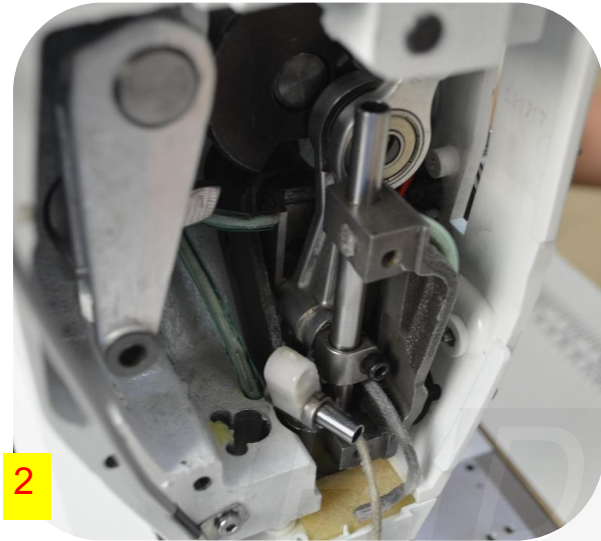

1. Insert the needle swing shaft assembly (Diagram 1) into the machine body (2), secure with the retaining ring (3), and install the shaft sleeve spacer retaining ring (4). Attach the crank (Z assembly) (5).

2. Install the needle bar (Diagram 6) and secure the needle. Move the shaft back and forth, left and right, to align the needle with the feed dog hole. Adjust until the needle is centered in the feed dog hole, then secure with screws 3 and 4. Set the stitch length adjustment dial to 0. Align the needle bar swing arm pin hole (Diagram 7) with the machine body mark and tighten screw 5.

## 15. Thread take-up mechanism assembling

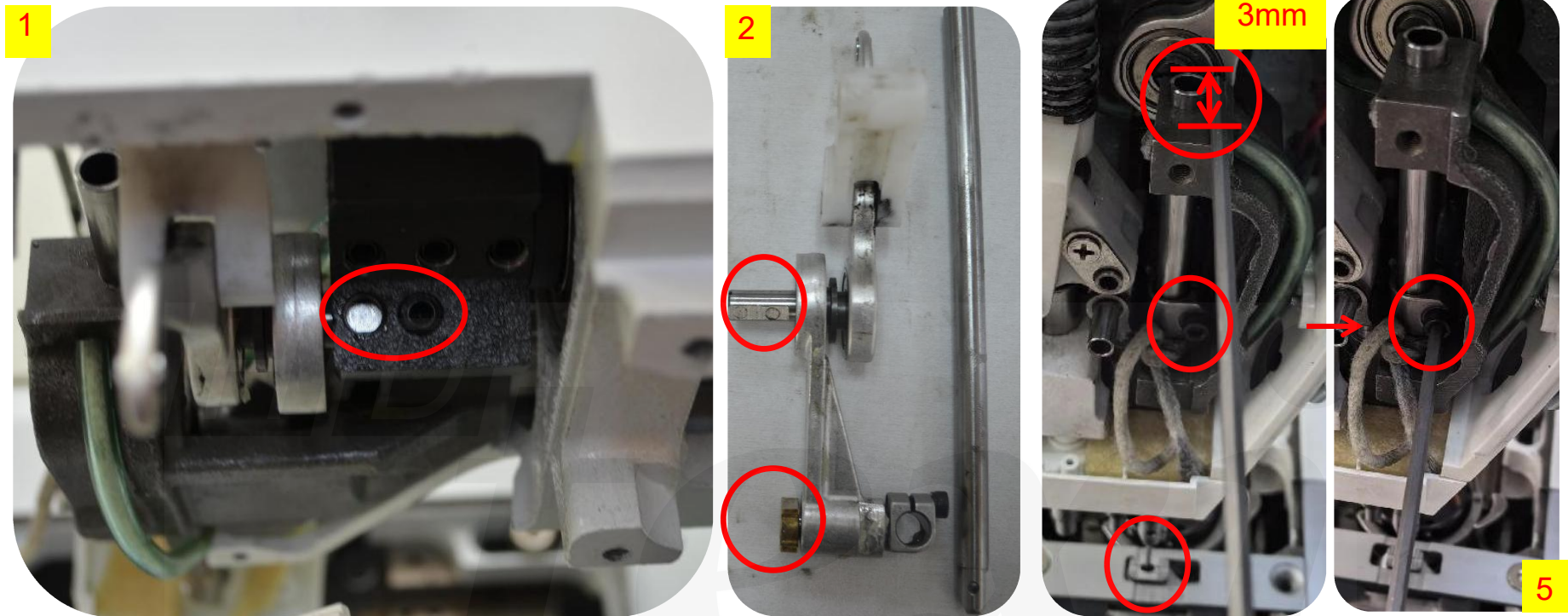

1. Insert the thread take-up lever assembly (2) into the needle bar balance crank hole. Adjust the plane (Diagram 1) and secure with two hex socket head cap screws. Place the sliding block into the guide rail, insert the needle bar from above through the upper hole of the needle bar swing frame, then through the needle bar clamp, and finally through the lower hole of the needle swing frame.  
Note: The needle clamp screw should be oriented to the right.

2. Move the needle bar to its lowest point, exposing about 3mm of the needle bar (Diagram 3). Tighten screw 5. Make final adjustments after powering on the machine.



## 16. Presser foot and needle swing mechanism assembling

1. Insert the small presser foot rod assembly (3) into the needle swing frame. Insert the presser foot rod alternate assembly (5) into the machine body, ensuring the small end of the presser foot rod sleeve is pushed up to the top. Secure it with two hex socket head cap screws on the back.

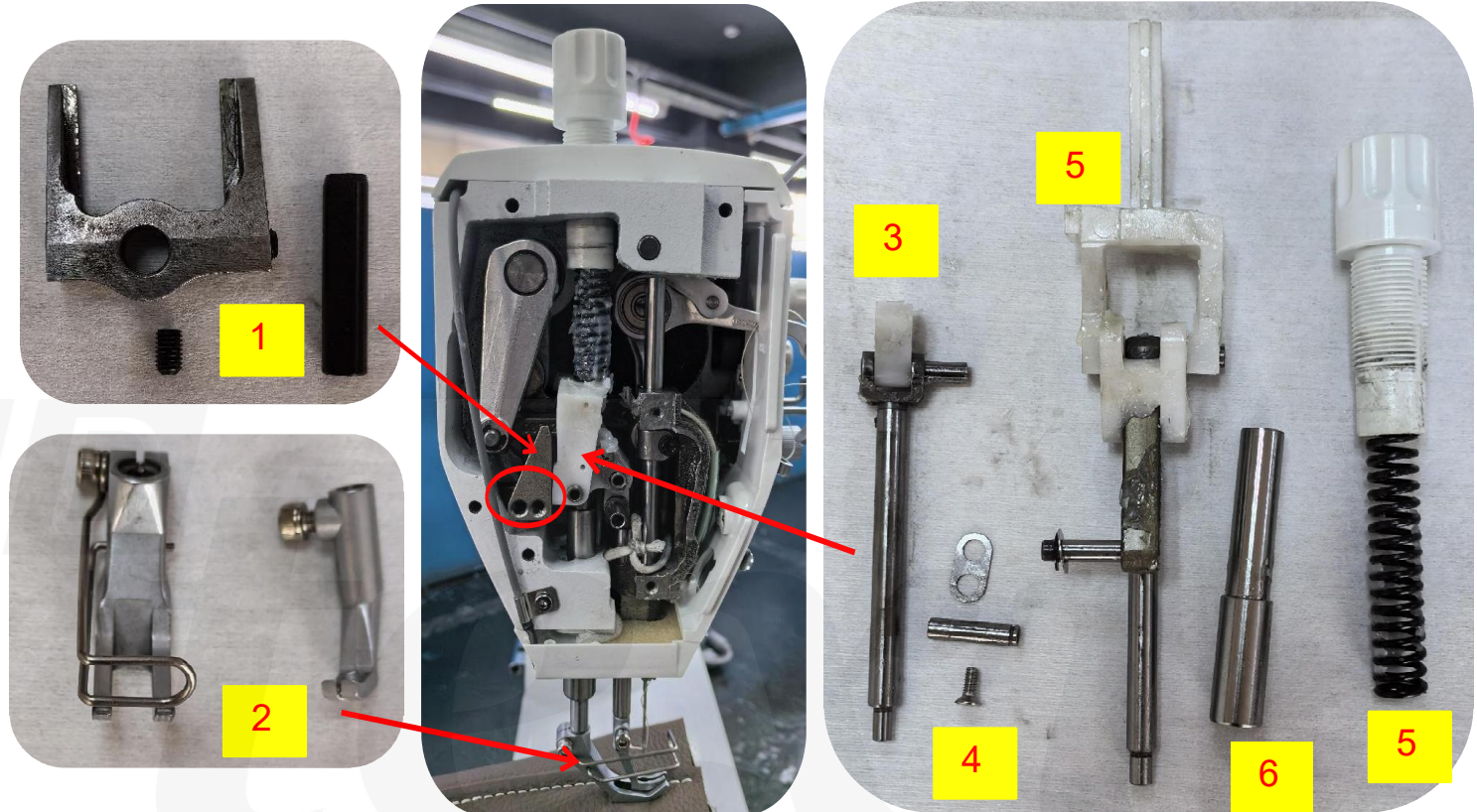

2. Place the connecting rod of the presser foot rod alternate assembly onto the center of the feed shaft crank assembly, then insert the upper feed crank connecting rod pin. Ensure no spacers are omitted and secure with hex socket head cap screws. Insert the connecting rod pin into the presser foot rod alternate assembly (Diagram 4), and insert the long double-hole spacer into the pin slot. Secure with cross-head screws. Install the presser foot pressure adjustment spring and adjustment bolt into the machine body (Diagram 5), setting the adjustment bolt height to 35mm. Adjust the size of the presser foot to center it with the needle (Diagram 2).

3. The triangular block (Diagram 1) should contact the presser foot rod alternate assembly. Insert it onto the washing shaft and secure with three hex socket head cap screws.

## 17. Lower feed mechanism adjusting

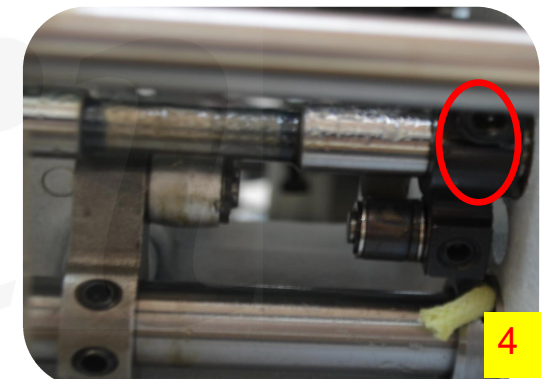
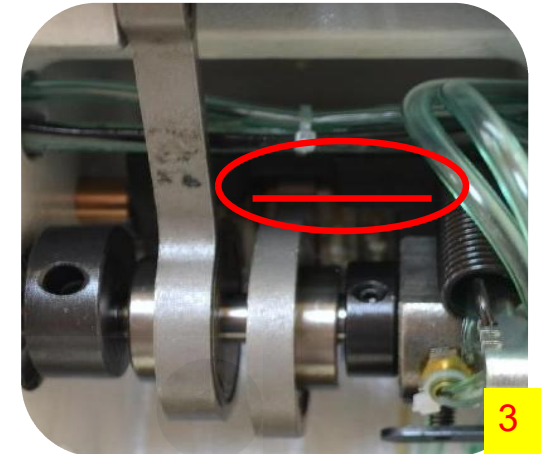
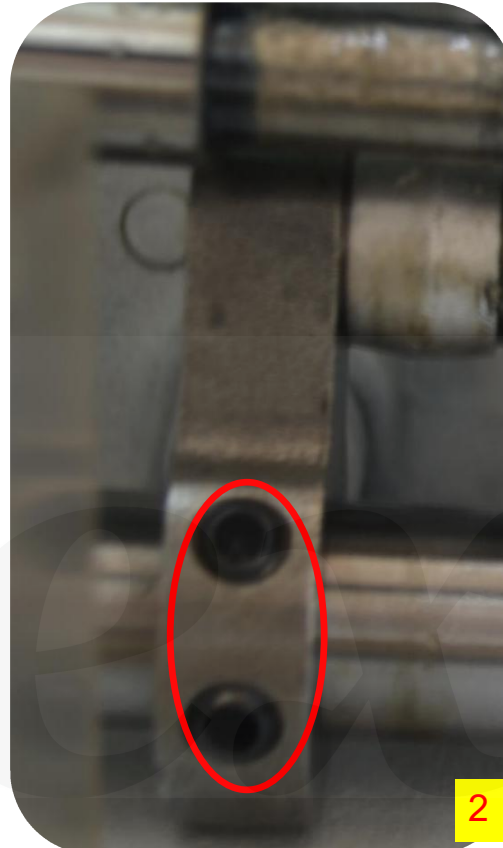

- Set the dial scale to zero.
- Ensure the needle is centered in the feed dog hole (Diagram 1).
- Loosen the crank (2) and the lower feed linkage (4) connecting rod (3).
- Adjust the connecting rod to ensure it is level by hand.
- If it is not level, loosen the screws shown in Diagram 4 and make adjustments.
- After achieving proper alignment, secure the connecting rod crank screws (2, 3, 4) individually.

## 18. Handwheel and belt cover assembling

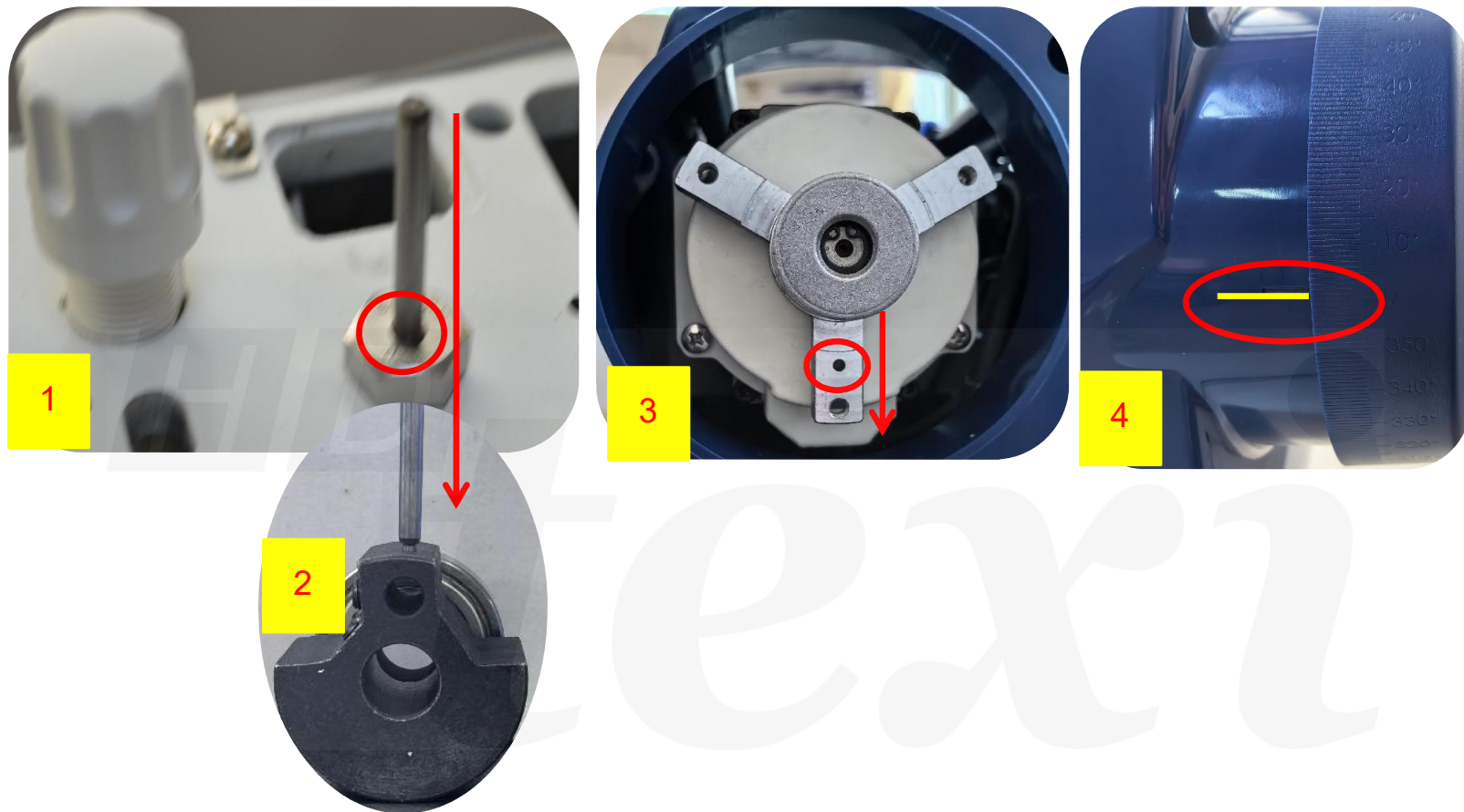

Insert the small end of the special insertion tool (Diagram 1) into the screw hole in the machine body, and then insert it into the needle bar balance crank hole (Diagram 2). Adjust so that the small hole on the flange (Diagram 3) is vertically aligned downward. Install the handwheel and ensure that the 0° mark on the handwheel (Diagram 4) aligns with the motor cover scale line. If not aligned, adjust the two hex socket head cap screws on the flange. Repeat the alignment check, then secure the flange and the handwheel.

## 19. Rotary hook mechanism assembling and adjusting

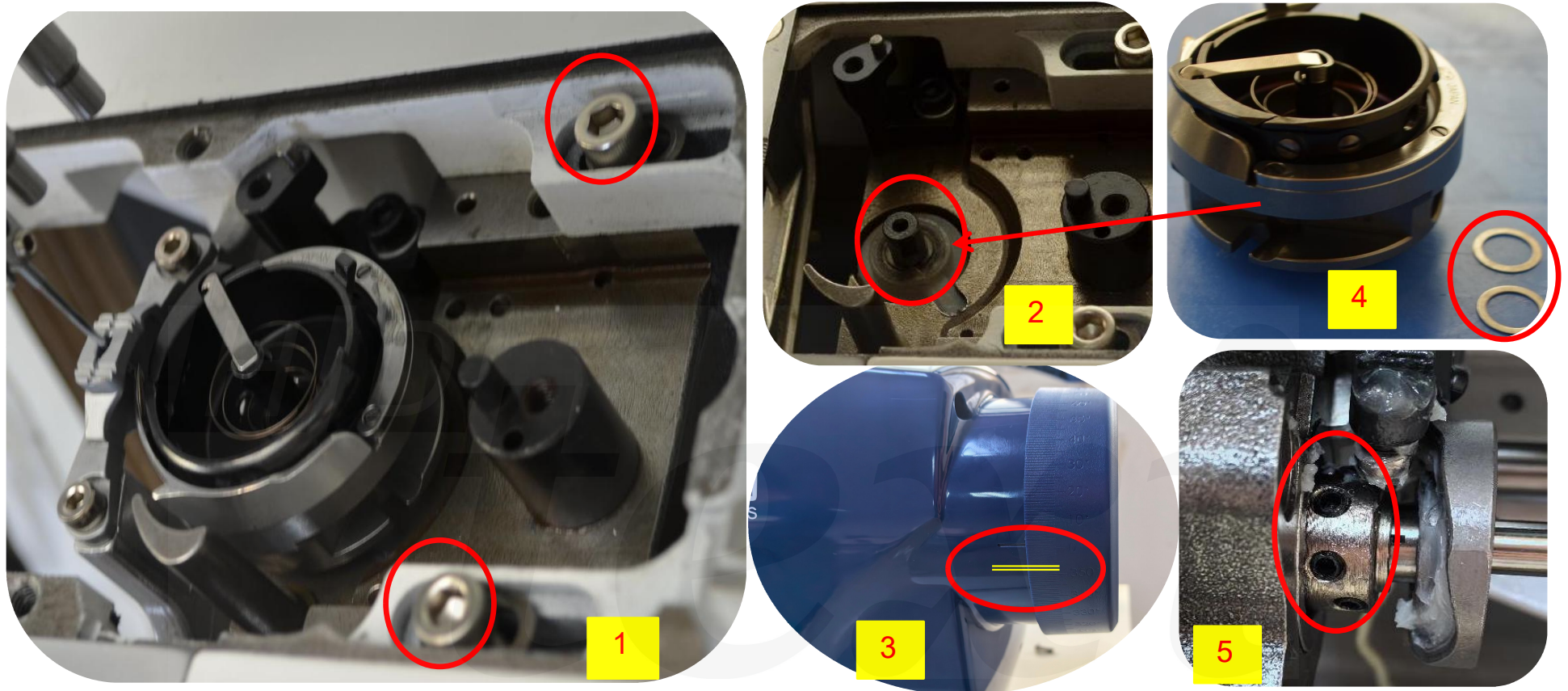

1.Place the two spacers (Diagram 4) into the rotary hook shaft (Diagram 2). Insert the rotary hook into the rotary hook shaft, press the rotary hook down fully, and align the first screw in a clockwise direction with the plane. Secure the two screws.

2.Move the rotary hook base left and right to align the needle tip with the center of the needle groove. The gap between the rotary hook and the needle should be 0-0.1mm or more. Adjust the needle guard gap and secure the two large hex socket head cap screws on the rotary hook base. Confirm the clearance between the rotary hook and the needle repeatedly.

3.Rotate the handwheel to 205°, aligning it with the motor cover scale line (Diagram 3). Ensure the handwheel does not move. Adjust the rotary hook so that the tip of the rotary hook aligns with the centerline of the needle groove. Secure the four hex socket head cap screws (Diagram 5).

## 19. Rotary hook mechanism assembling and adjusting

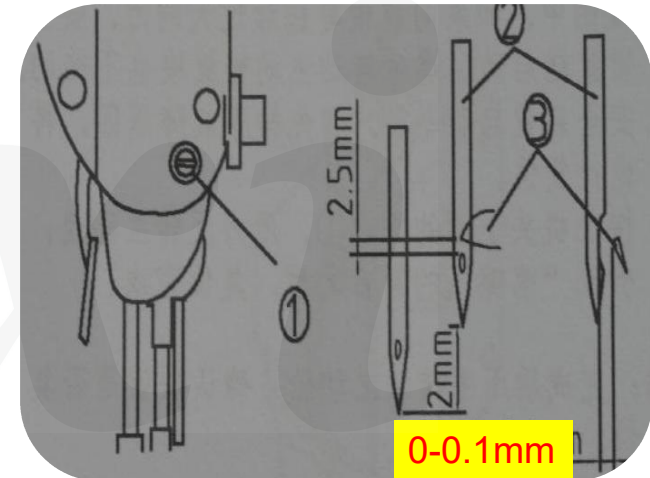
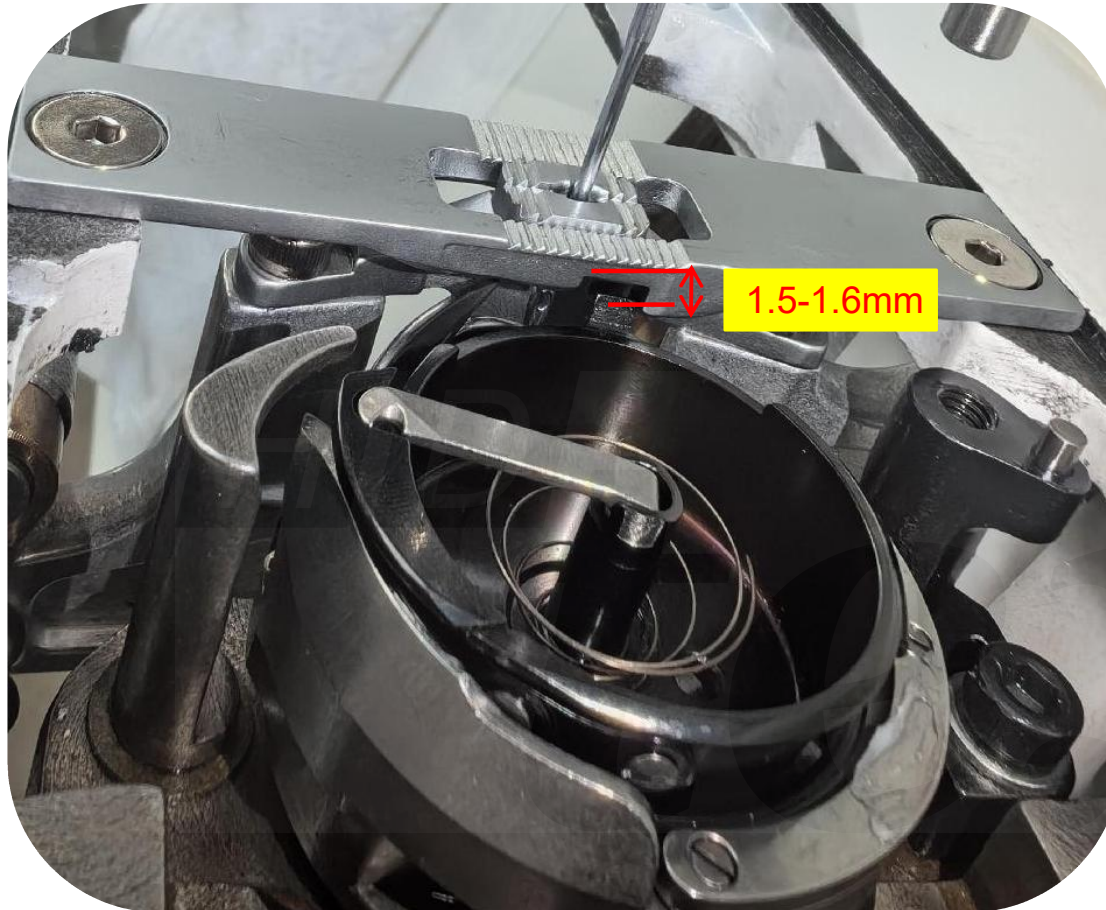

Use the spacer (Diagram 1) to adjust the gap between the rotary hook boss and the needle plate groove to 1.5-1.6mm.

The thickness of the spacer (Diagram 1) affects the gap between the rotary hook boss and the needle plate groove. For coarse thread, the gap should be greater than 1.6mm, but the rotary hook should not come out. For fine thread, if the gap is less than 1.5mm, it can cause thread feeding issues and is a common cause of forming bottom thread loops.

## 20. Oil supply mechanism assembling

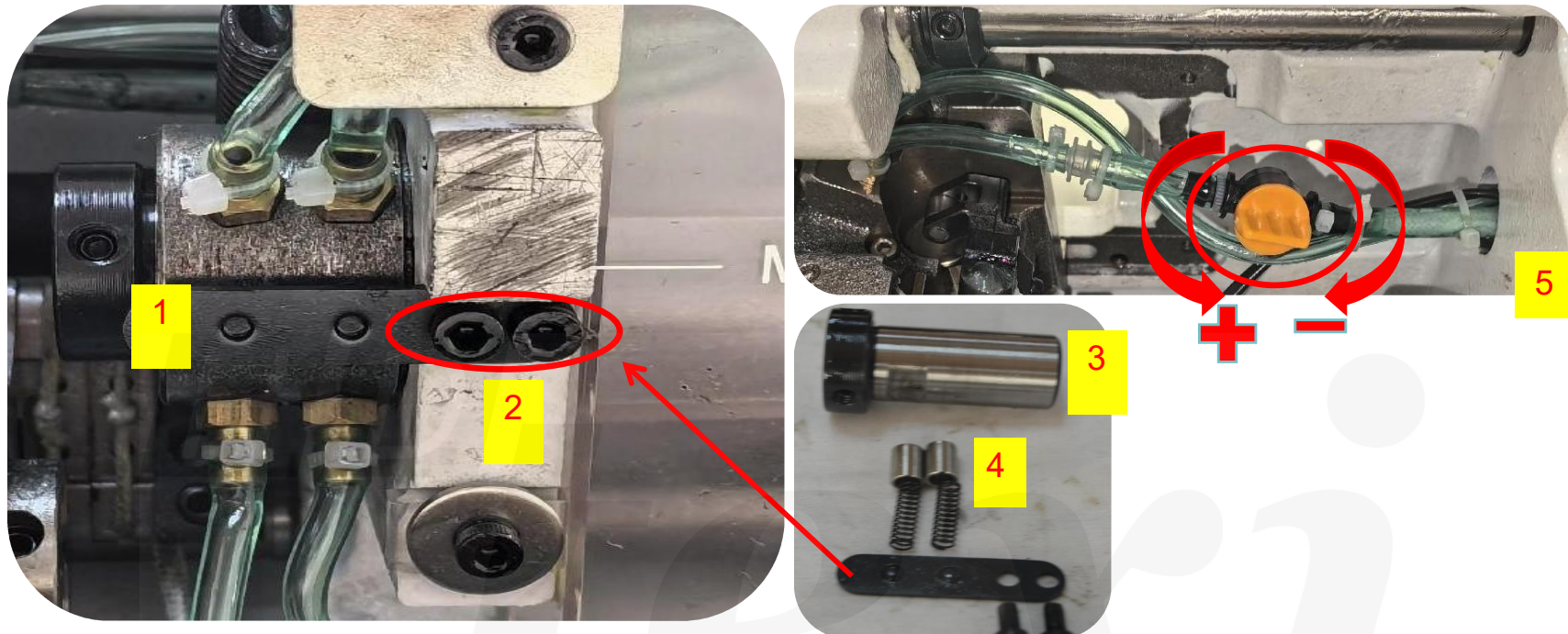

1. Insert the oil pump shaft into the oil pump base assembly and secure it with three hex socket head cap screws. Place the oil suction plunger (4) into the oil pump assembly holes, insert the two plunger springs, and install the plunger cover. Secure the plunger cover screws, ensuring the protruding part of the cover compresses the springs.
2. Adjust the rotary hook oil flow control valve (Diagram 5) according to the diagram.
3. Standard oil supply for the rotary hook: At a speed of 1500 rpm, with 5 seconds ON and 5 seconds OFF, after running for 5 minutes, the oil should cover a 74x52mm area of paper placed horizontally near the thread take-up lever and cutting blade seat. The oil droplets should form a line.

## 21. Material feeding mechanism adjusting

### Feed dog adjustment

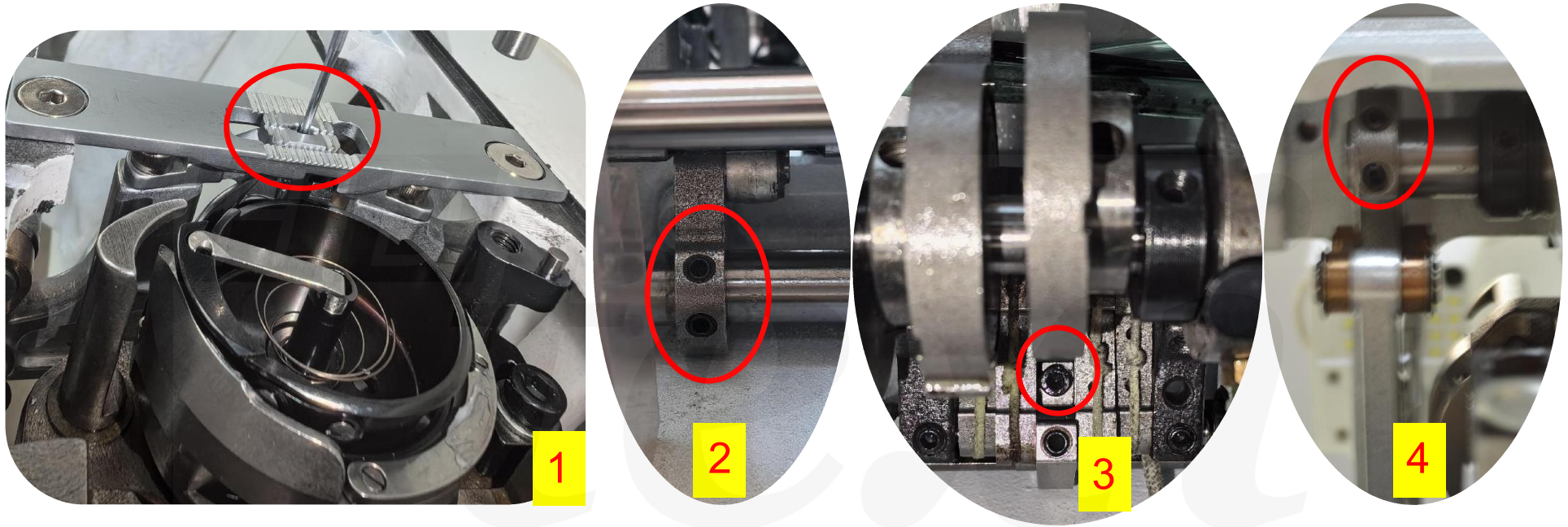

1. Install the feed dog, needle plate, and set the stitch length dial to 9mm. Rotate the handwheel to confirm that the feed dog aligns equally with the needle plate hole both front and back. To adjust, loosen the three hex socket head cap screws (Diagrams 2 and 3), adjust the feed dog to center it on the needle plate, and then tighten the three screws.

2. Rotate the handwheel to 190°, ensuring that the feed dog (Diagram 1) protrudes 0.5mm above the needle plate surface. To adjust, loosen the two screws (Diagram 4), set the standard, and then tighten the screws.

## 22. Thread cutting mechanism installing and adjusting



1. Install the moving knife, fixed knife, and thread clamp spring.
2. Place two spacers under the moving knife and one on top. Note: The lower spacers ensure the moving knife is 0.5mm higher than the rotary hook lining, and the moving knife should be greater than the fixed knife by 0.2mm.
3. Move the moving knife by hand until it just touches the fixed knife. Adjust the thread clamp spring to contact the moving knife, then secure with hex socket head cap screws. The "0" mark on the moving knife ends "↓" (Diagram 1). If adjustments are necessary, loosen the hex screws, adjust the position, and then tighten the screws.

**Note: Ensure that the moving knife and fixed knife are properly adjusted and confirm the cutting performance. If the thread is not cut properly, readjust using the above method.**



## 22. Thread cutting mechanism installing and adjusting

Thread cutting cam adjustment

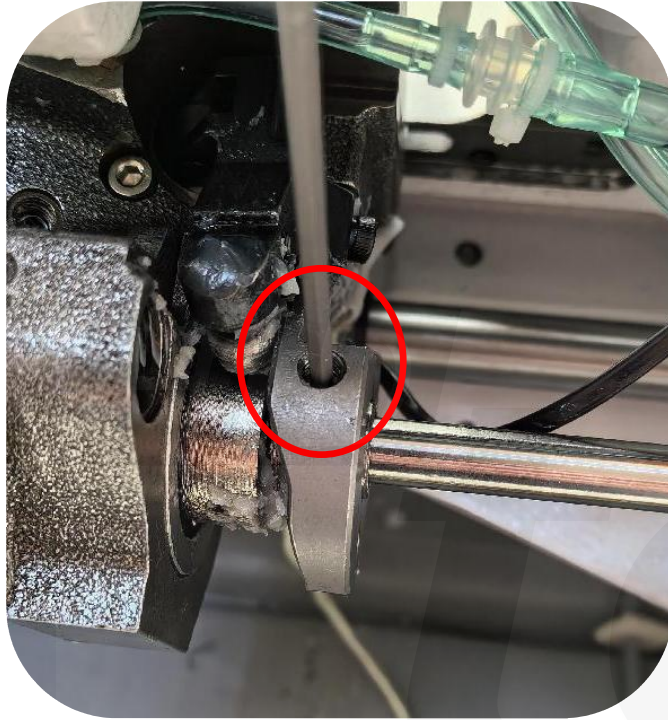

Rotate the handwheel to 65°, aligning it with the motor cover scale line. Loosen the cutting cam screws and adjust the gap between the cutting cam and the ball bearing to  $0.5 \leq 0.1 \text{ mm}$ . Once the cutting is complete, secure the two hex socket head cap screws on the cutting cam.

## 23. Hook thread take-up lever adjusting

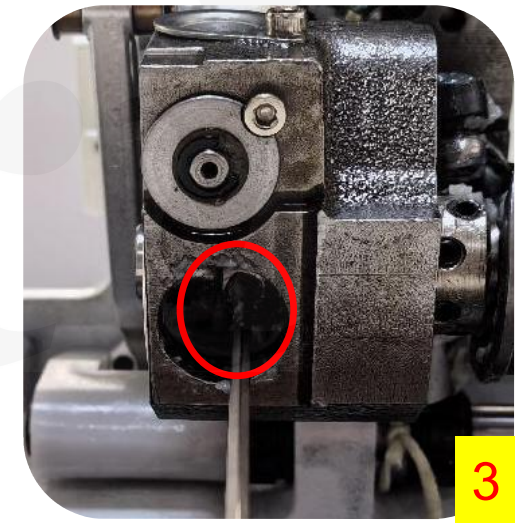
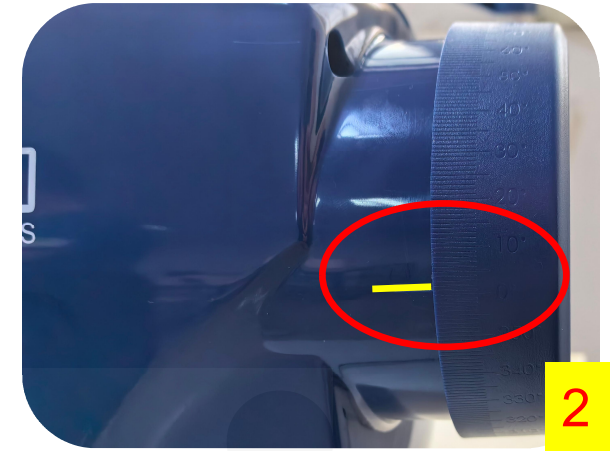
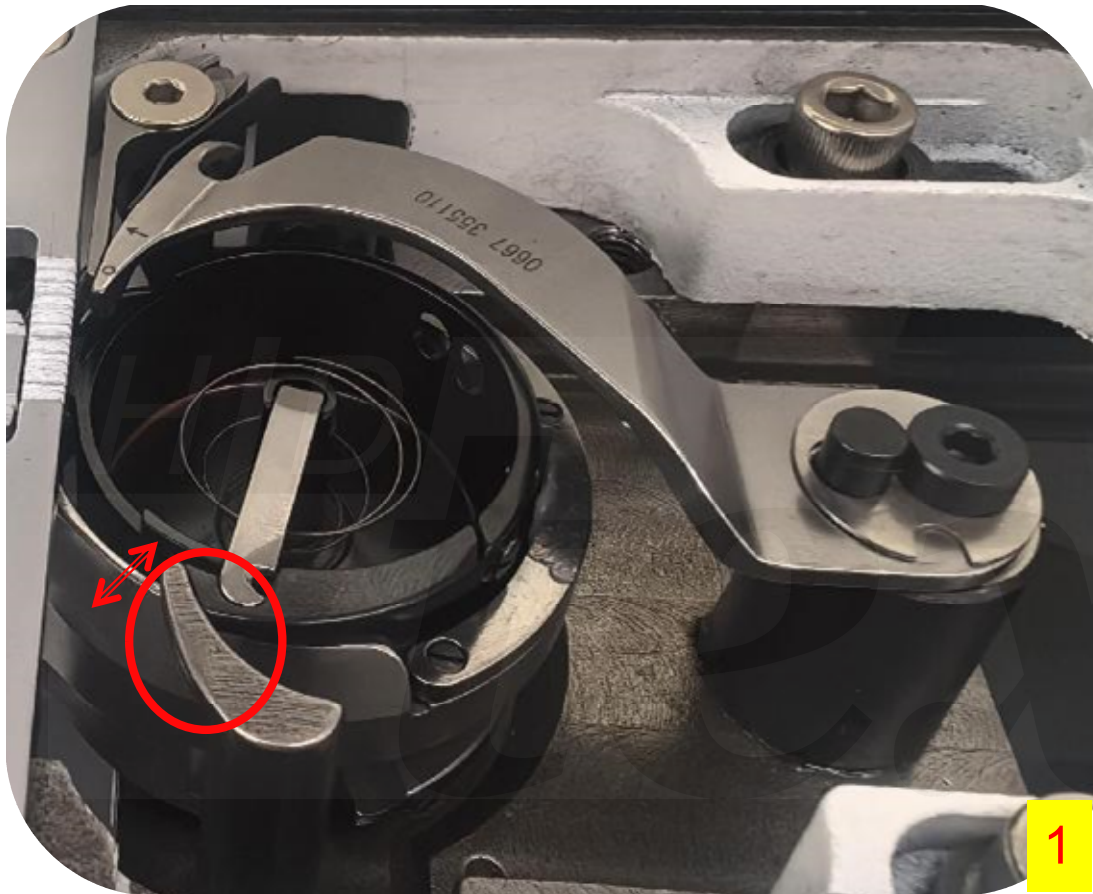

- Rotate the handwheel to 260°, aligning it with the motor cover scale line.
- Loosen the three hex socket head cap screws and adjust the thread take-up lever to achieve the maximum distance from the rotary hook lining.
- Ensure that the distance between hook shuttle and the take-up lever is not less than 1mm, then secure the three screws.

## 24. Thread clamping mechanism assembling and debugging

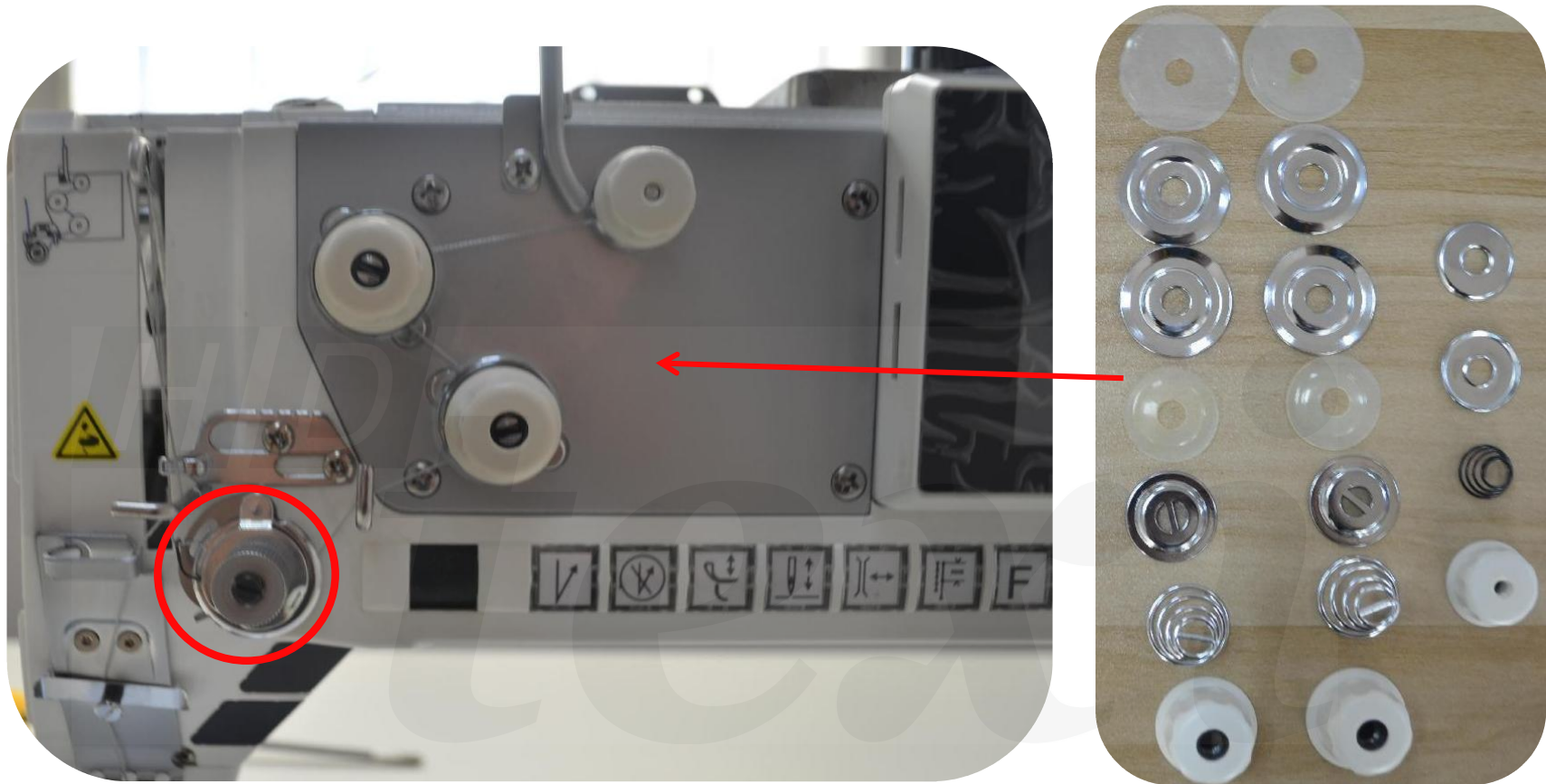

1. Install the three thread clamp sub-assemblies. Adjust the height of the thread take-up spring to 8mm (adjust within the range of 6–10mm based on the user's sewing requirements, and evaluate based on the stitch quality).
2. Set the upper thread take-up spring tension to  $1.2\text{N} \pm 0.1\text{N}$  and the lower thread tension to  $0.4\text{N} \pm 1.2\text{N}$ .
3. The main thread clamp rotates clockwise to increase the upper thread tension and counterclockwise to decrease it.
4. The thread clamp should open by 0.3–0.5mm during cutting. Uneven or insufficient opening of the thread clamp during cutting can cause thread breakage.

## 25. Needle and feed dog timing adjustment

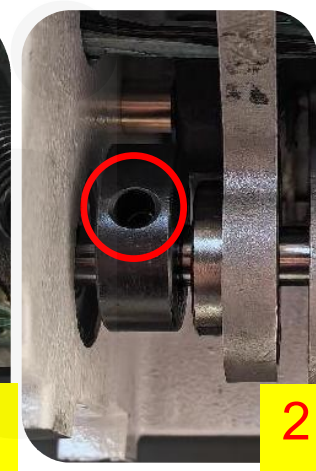
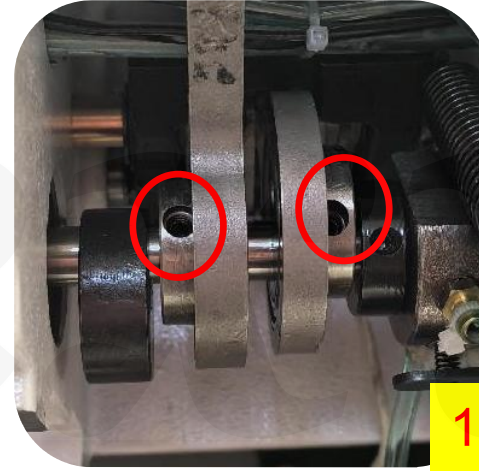
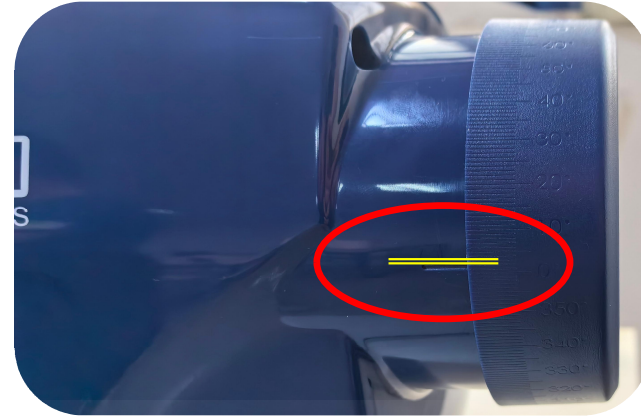
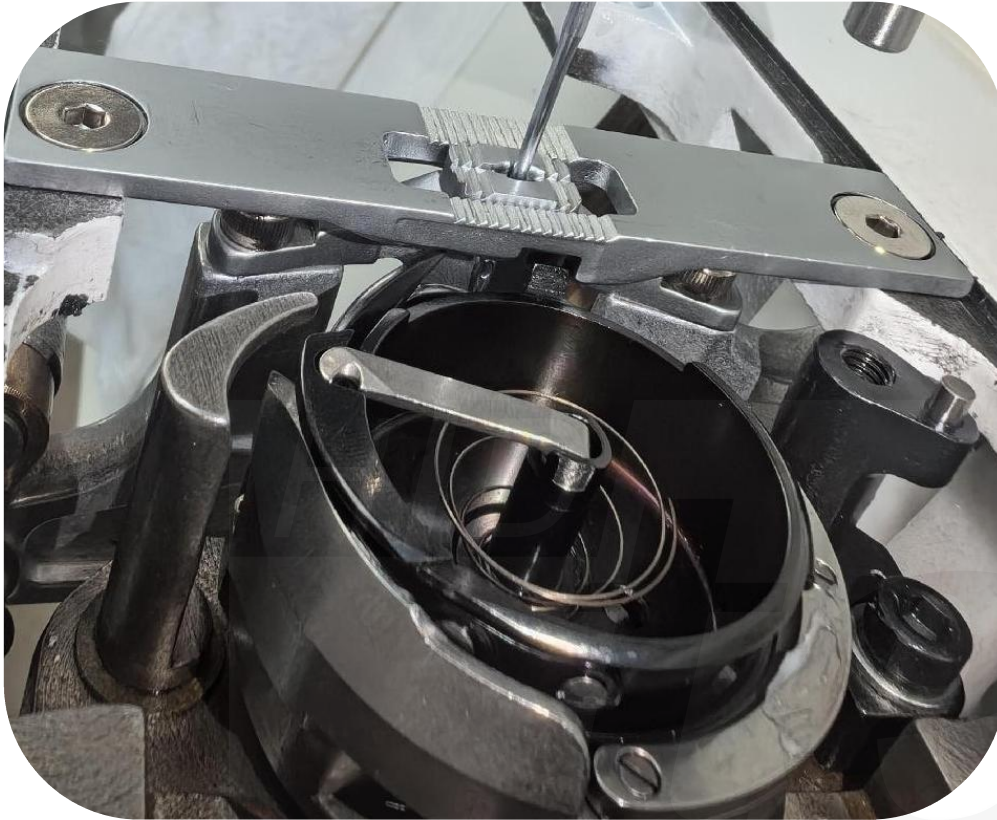



1. Rotate the handwheel to  $190^{\circ}$ , aligning it with the motor cover scale line. Press the reverse sewing handle and ensure the needle and feed dog are in a stationary position. If misaligned, loosen the two hex socket head cap screws (Diagram 1), adjust, and then secure the screws. Loosen the two hex socket head cap screws to adjust the cam so that the feed dog protrudes 0.5mm above the needle plate, then tighten the screws.
2. Repeat the above steps with the handwheel rotated to  $210^{\circ}$ . Align the screw (Diagram 2) with the bottom plate surface and secure one hex socket head cap screw.

**Note:** After confirming that the adjustments are correct, ensure that all hex socket head cap screws (Diagrams 1 and 2) are tightened.

## 26. Operation panel debugging



1. Turn on the power to display the upper interface. Press  to unlock, then press  to display the right interface.

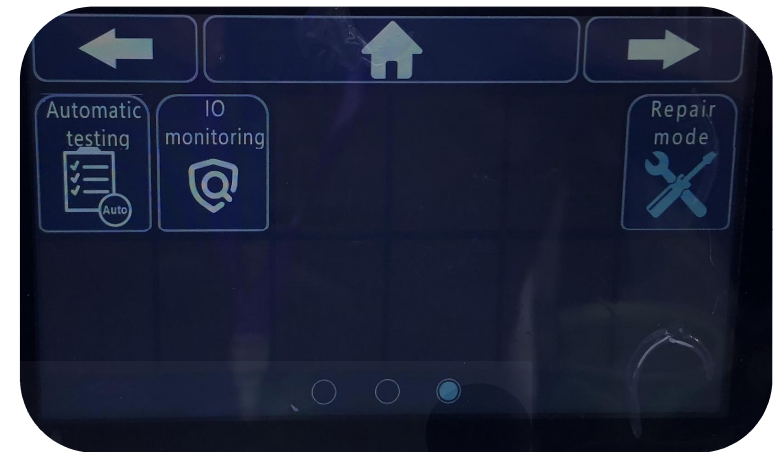

2. Press  to enter the maintenance mode, displaying the bottom left interface.

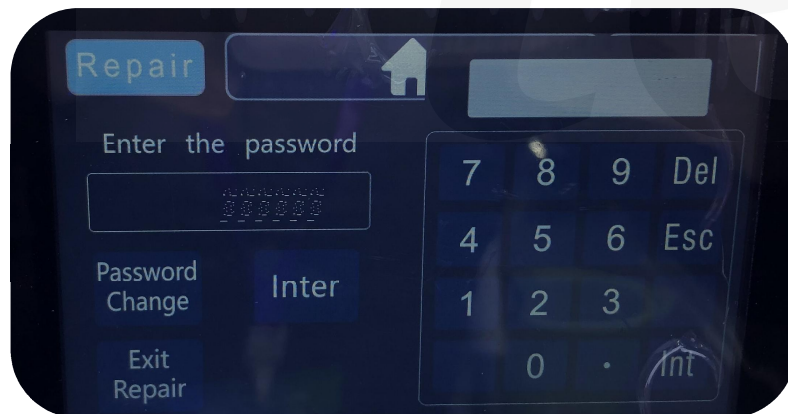

3. After the upper interface is displayed, enter the password 888888 to access the program.

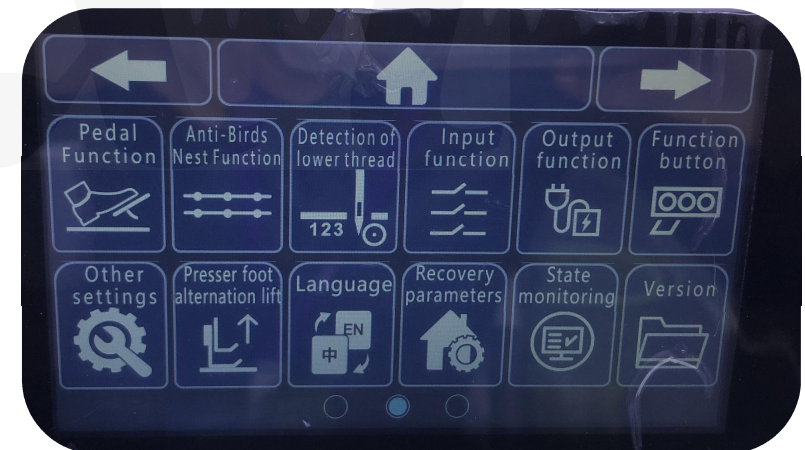

4. Once the upper interface is displayed, select the required function for setting.

## 26. Operation panel debugging

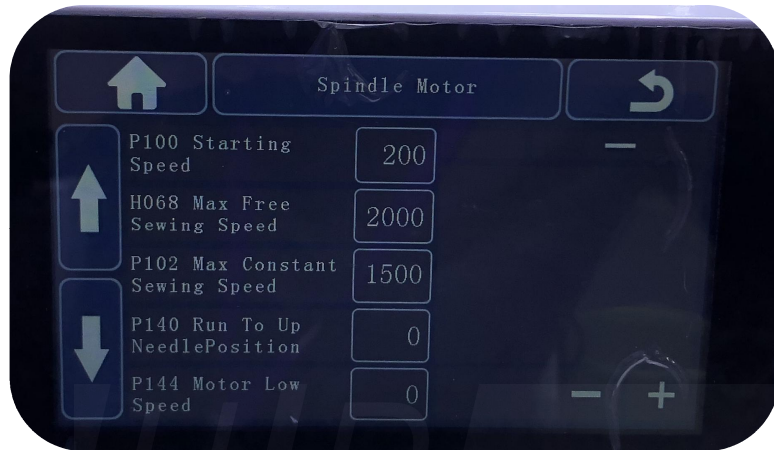

1. On the display page, select the speed.

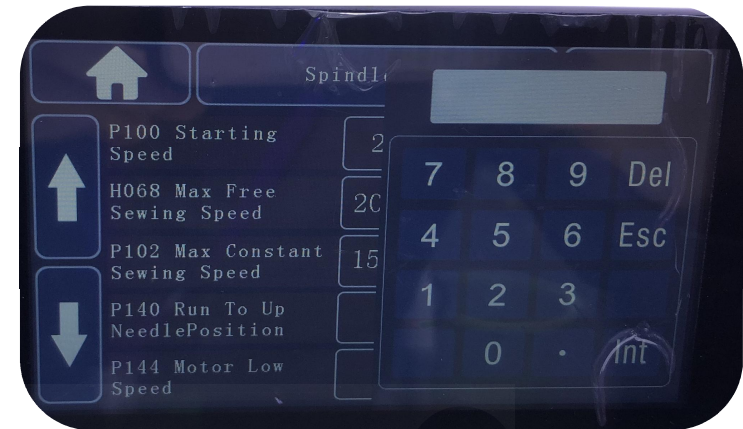

2. Enter the desired speed and press Int to confirm, allowing the system to remember it.

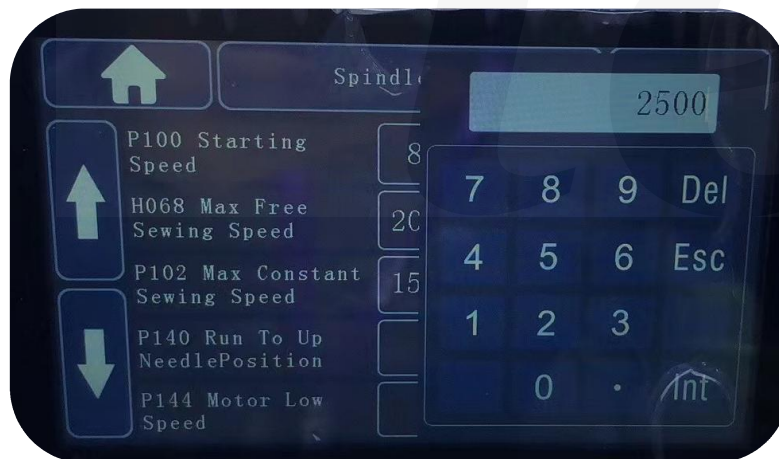

3. On the display page, select a speed of 2500 RPM.

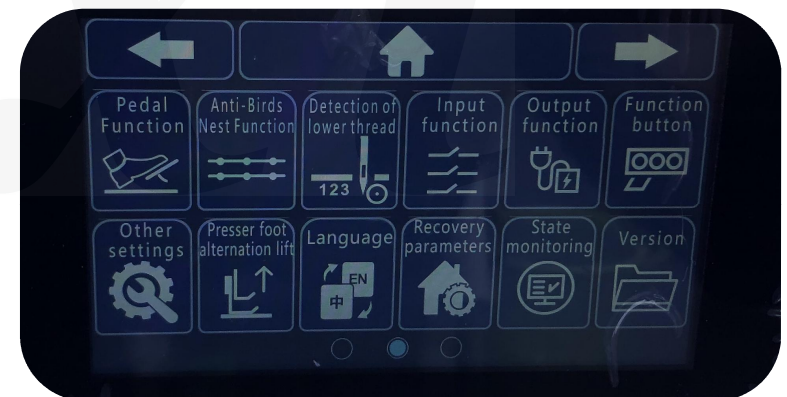

4. On the display page, select the desired function and practice repeatedly, as the operation method is the same.

## 26. Operation panel debugging

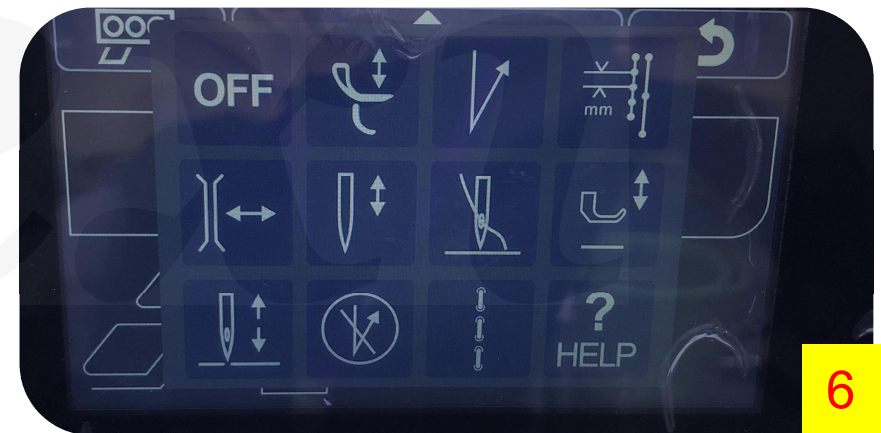
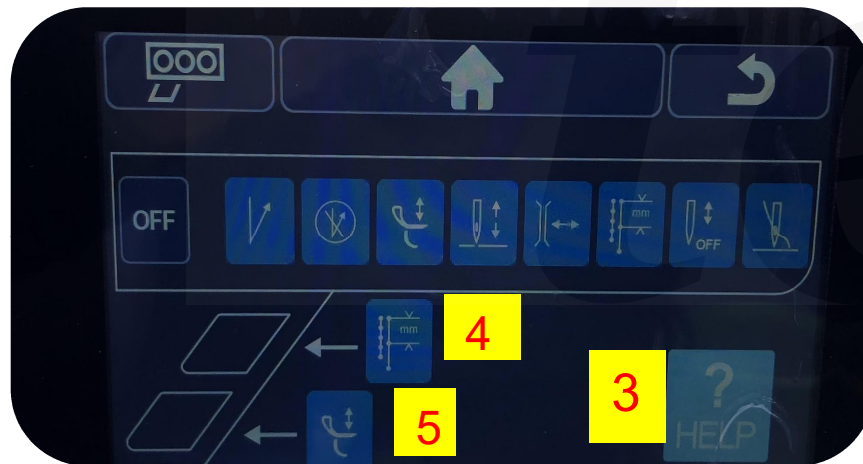

Diagrams 1 and 2 show shortcut keys for easy use by operators. Long press the shortcut key in Diagram 1 or 2 for ten seconds to enter the interface shown in Diagram 3. Use the buttons in Diagram 4 or 5 to switch to the interface in Diagram 6 and change the button functions. The button functions are described on the next page.

## 26. Operation panel debugging

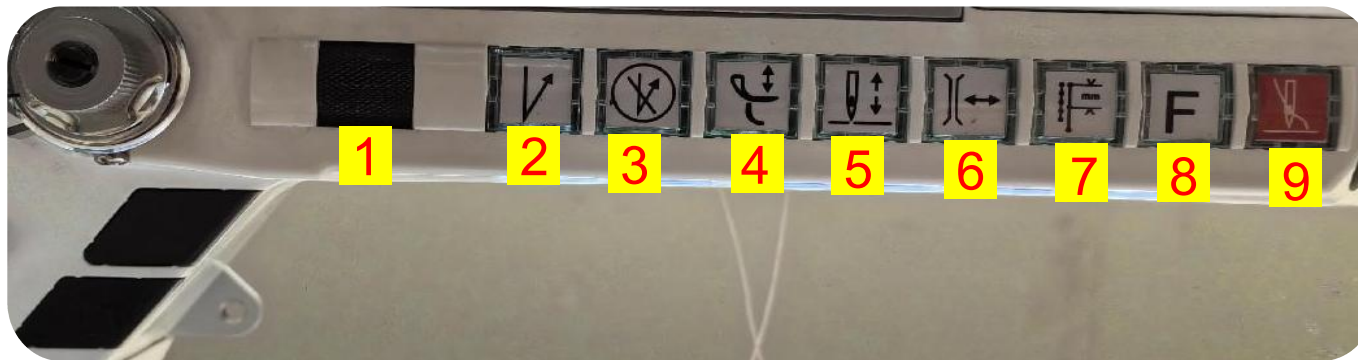

Diagram 1: Electronic handwheel - slide to rotate the machine.

Diagram 2:  Backtacking sewing function button.

Diagram 3:  Cancel backtacking sewing function button.

Diagram 4:  HP function button - long press for ten seconds to enter the interface in Diagram 10 to set HP function mode and HP linkage function.

Diagram 5:  Tack stitch function button.

Diagram 6:  Compensation thread clamp function button - long press for ten seconds to enter the interface in Diagram 11 to set the compensation thread clamp function mode and compensation function follower.



Diagram 7:  Long stitch switching function button - long press for ten seconds to enter the interface in Diagram 12 to set the long stitch function mode and long stitch follower.

Diagram 8:  Reserved button - can be used for CP function in double needle machines.

Diagram 9:  Safe threading mode button - pressing this button stops the motor and raises the needle to the highest point, making it easier to thread and preventing injury from accidentally pressing the pedal while threading.



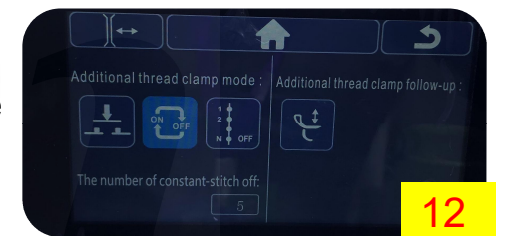
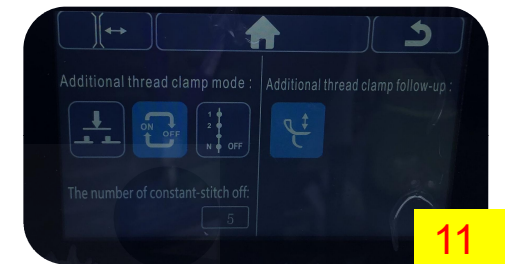
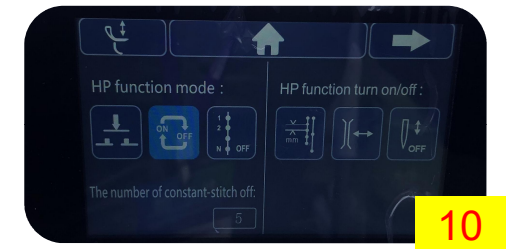

## 27. Control box wiring connection



The diagram above shows the wiring connections for the control box. Please match the plugs to the corresponding sockets based on the plug size and pin count. Do not insert them incorrectly or apply excessive force to avoid damaging the plugs and sockets.

**NOTE: Tighten the fixation screws to ensure the plug connection**

## 28. External parts assembling

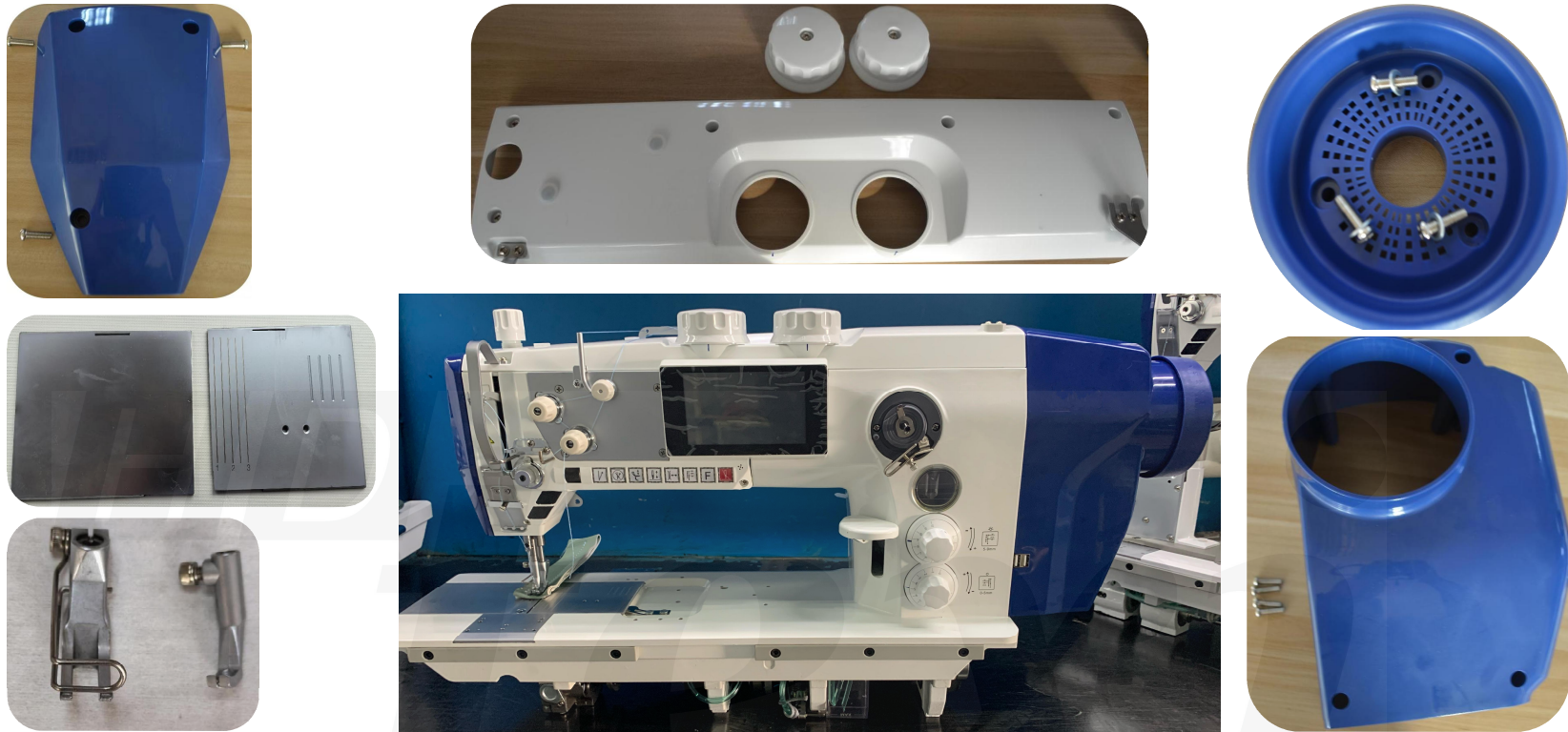

1. Install the left and right push plates, ensuring they are neither too tight nor too loose. Adjust if necessary.
2. Align the panel with the machine casing holes and secure with three cross-head screws. Install the large and small presser feet and adjust them to be centered on the needle.
3. Place the plastic top cover on the machine head and secure with six cross-head screws. Install the two feed adjustment wheels.
4. Install the motor cover and the corresponding handwheel.

**Note:** The handwheel flange component should have two holes facing vertically downwards. Do not apply excessive torque to the plastic parts, generally 10-15 kgf, to avoid damaging the plastic components

## 28. External parts assembling

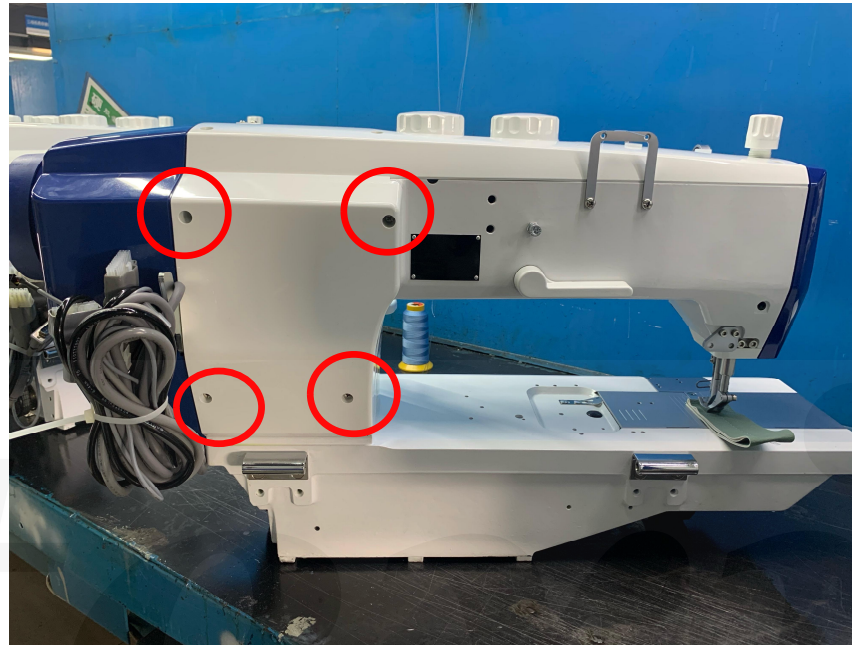

Install the machine head back cover and secure with four cross-head screws.  
Ensure the torque is 10-15 kgf to prevent damage to the plastic components due to excessive torque.

# Troubleshooting:

## 1. Thread Breakage:

- A. There are scratches or burrs on the thread path, needle tip, rotary hook tip, or the fixed hook on the needle plate... --- Repair with fine sandpaper or replace.
- B. Upper thread tension is too strong... --- Reduce upper thread tension.
- C. Gap in the rotary hook guide is too large... --- Reduce the gap.
- D. Needle and rotary hook tip collide... --- Re-adjust rotary hook clearance.
- E. Insufficient lubrication in the rotary hook... --- Increase the amount of oil in the rotary hook.
- F. Upper thread tension is too weak... --- Increase upper thread tension.
- G. Thread take-up spring is too strong, resulting in small displacement... --- Reduce take-up spring tension and increase displacement.
- H. Needle and rotary hook synchronization is too fast or too slow... --- Re-adjust rotary hook speed.

## 2. Skipped Stitches:

- A. Needle and rotary hook synchronization is too fast or too slow... --- Re-adjust rotary hook speed.
- B. Presser foot pressure is too weak... --- Increase presser foot pressure appropriately.
- C. Incorrect clearance between the upper end of the needle hole and the rotary hook tip... --- Re-adjust rotary hook clearance.
- D. Incorrect position of the needle seat... --- Re-adjust needle seat.
- E. Incorrect needle size... --- Replace with corresponding needle.
- F. Skipped stitches at the beginning of sewing (2-3 stitches)... --- Increase the bottom thread tension.
- G. Long stitches at the beginning of sewing... --- Ensure the thread-catching function at the beginning of sewing is effective.

## 3. Poor Thread Tension:

- A. The bottom thread is not clamped by the rotary hook tension spring... --- Properly thread the bottom thread.
- B. There are wear and tear or damage in the thread path, such as the feed dog and thread guide rail... --- Repair with fine sandpaper or file, replace if severe.
- C. The lock core does not slide or rotate smoothly...

# Troubleshooting:

## **4. Thread Pulls Out from Needle When Cutting Thread:**

- A. Thread tensioner tension is too strong... --- Reduce tension.
- B. Take-up spring stroke is too large... --- Reduce stroke.
- C. Cutting thread in an area without fabric... --- Sew on fabric, move thread hook towards the take-up lever.

## **5. Thread Pulls Out from Needle During Sewing:**

- A. Thread tensioner tension is too strong... --- Reduce tension.
- B. Shape of the thread clamp spring is incorrect... --- Replace or repair.
- C. Bottom thread tension is too weak... --- Increase bottom thread tension.
- D. Take-up spring stroke is too large... --- Reduce stroke.
- E. Cutting thread prematurely in an area without fabric... --- Sew on fabric, move thread hook towards the take-up lever.

## **6. Poor Knotting at the Beginning of Sewing:**

Bottom thread clamp pressure is too strong... --- Reduce bottom thread clamp pressure. Confirm the alignment of the moving knife, fixed knife, and bottom thread clamp, and the hold of the upper thread on the fabric.

## **7. Poor Thread Cutting:**

- A. Poor meshing of the moving knife and fixed knife blades.
- B. Damaged blade edges.
- C. Weak bottom thread tension... --- Replace or adjust.

## **8. Inability to Cut Thread, Residual Thread (Poor Thread Cutting with Short Stitches at the Beginning of Sewing):**

Upper thread tension too strong during cutting, causing thread breakage at the beginning of sewing... --- Adjust upper thread tension properly.

## **9. Fabric Warping when Sewing Thick Materials:**

Insufficient feed amount... --- Lower the feed dog height to reduce feed amount.

## Common issue analysis and solutions:

### **10. During the sewing process and at the end of sewing, missing stitches often occur;**

The thread is too thick; the fabric is too thick; the fabric surface has a coating; or there is debris or thread ends in the bottom thread clamp.

Solution: Choose suitable fabric and thread, clean the debris or thread ends inside the bottom thread clamp. If necessary, adjust the thread clamp and add a softener or silicone oil to the thread.

### **11. When sewing leather or genuine leather, abrasion may occur.**

Cause Analysis: The presser foot pressure is too strong; the lower part of the presser foot is damaged; new machine with a new presser foot.

Solution: Adjust the presser foot pressure appropriately according to the fabric; replace the presser foot with a plastic or nylon presser foot suitable for leather to reduce friction between the presser foot and the leather.

## CE DECLARATION OF CONFORMITY

Distributor:

Strima Sp. z o.o.

Swadzim, ul. Poznańska 54

62-080 Tarnowo Podgórne, Poland

We declare, that the following product:

Industrial sewing machine Texi brand

Model: **NOVA 2609, NOVA 3212, NOVA TN 3212, NOVA P-OS 3212**

Has been designed and manufactured in compliance with provisions of the following CE directives:

2006/42/EC - Machinery Directive

2014/35/EU - Low Voltage Directive

2014/30/EU - Electro Magnetic Compatibility

Applied harmonized standards:

EN ISO 12100:2010

EN ISO 10821:2005

EN 60204-1:2018

EN 60204-31:2013

Swadzim 03.03.2024

Strima Sp. z o.o.

## NOTES

---

---

---

---

---

---

---

---

---

---

---

---

---

---

---

---

---

---

---

---

---

---

---

Dealer:

**HD** *taxi*